



# User Manual

User Manual Version A for Software Versions 1.0.426+



## EC DECLARATION OF CONFORMITY

This is to certify that the:

### SD11 DIGITAL MIXING CONSOLE WORKSURFACE

From serial number 110020-1103

Manufactured by:

**DIGICO (UK) LIMITED  
UNIT 10  
SILVERGLADE BUSINESS PARK  
LEATHERHEAD ROAD  
CHESSINGTON SURREY  
KT9 2QL  
UNITED KINGDOM  
TEL: (+44) 01372 845 600  
FAX: (+44) 01372 845 656**

Conforms with the protection requirements of the Council Directive's 2004/108/EC and 2006/95/EC, relating to Electromagnetic Compatibility and Low Voltage Directive by the application of the following standards:

**EN55103-1 2009 Emission standard  
EN55103-2 2009 Immunity standard  
EN60065 2002 A1 2006 Low voltage directive**

Signed: .....  
John Robert Stadius

Position: Technical Director

Date: 15th MARCH 2011



## EC DECLARATION OF CONFORMITY

This is to certify that the:

### **D-RACK AUDIO I/O INTERFACE**

From serial number 980001

Manufactured by:

**DIGICO (UK) LIMITED  
UNIT 10  
SILVERGLADE BUSINESS PARK  
LEATHERHEAD ROAD  
CHESSINGTON SURREY  
KT9 2QL  
UNITED KINGDOM  
TEL: (+44) 01372 845 600  
FAX: (+44) 01372 845 656**

Conforms with the protection requirements of the Council Directive's 2004/108/EC and 2006/95/EC, relating to Electromagnetic Compatibility and Low Voltage Directive by the application of the following standards:

**EN55103-1 2009 Emission standard  
EN55103-2 2009 Immunity standard  
EN60065 2002 A1 2006 Low voltage directive**

Signed: .....  
John Robert Stadius

Position: Technical Director

Date: 12<sup>th</sup> April 2010

## Copyright © 2011 Digico UK Ltd

### All rights reserved.

No part of this publication may be reproduced, transmitted, transcribed, stored in a retrieval system, or translated into any language in any form by any means without the written permission of Digico UK Ltd. Information in this manual is subject to change without notice, and does not represent a commitment on the part of the vendor. Digico UK Ltd shall not be liable for any loss or damage whatsoever arising from the use of information or any error contained in this manual.

All repair and service of the SD11 product should be undertaken by Digico UK Ltd or its authorised agents. Digico UK Ltd cannot accept any liability whatsoever for any loss or damage caused by service, maintenance, or repair by unauthorised personnel.

### Software License Notice

Your license agreement with Digico UK Ltd, which is included with the SD11 product, specifies the permitted and prohibited uses of the product. Any unauthorised duplication or use of Digico UK Ltd software, in whole or in part, in print or in any other storage and retrieval system is prohibited.

### Licenses and Trademarks

The SD11 logo and SD11 name are trademarks, and Digico UK Ltd and the Digico UK Ltd logo are registered trademarks of Digico UK Ltd. Microsoft is a registered trademark and Windows is a trademark of Microsoft Corp.

Digico (UK) Ltd  
Unit 10  
Silverglade Business Park  
Leatherhead Road  
Chessington  
Surrey  
KT9 2QL  
England  
Telephone: +44 (0)1372 845600  
Fax: +44 (0)1372 845656  
Email: sales@digiconsoles.com  
WWW: http://www.digiconsoles.com

### Manual Issue and Date: Issue A - April 2011 - For Version 1.0.426+ Software

### Licence Agreement

**"Product":** SD11 software product produced by Digico UK Ltd intended for use on Target Platform identified below.

**"Target Platform":** Digico SD11 Digital Console system.

In return for the payment of the one-time fee, the Customer (identified at the end of this Agreement) receives from Digico UK Ltd a licence to use the Product subject to the following terms and conditions.

1. The Product may be used without time limit by the Customer on the Target Platform.
2. The Customer must register the Product with Digico UK Ltd. Registering the Product is deemed an acceptance of the terms and conditions in this agreement.
3. The Product and its licence are not transferable, and the Customer is not permitted to onward-license to any third party. The Customer indemnifies Digico UK Ltd against any and all claims and actions arising from third party use of copies of the Product made by the Customer.
4. The Customer agrees not to attempt to decompile the object code of the Product otherwise than in circumstances specifically provided for by law, and then only after consultation with Digico UK Ltd.
5. The Customer agrees not to use, or licence the Product for use, with equipment other than the Target Platform.
6. The Customer agrees not to modify the Product without the prior written consent of Digico UK Ltd.
7. This Agreement applies to any enhancement or upgrades that may become available for the Product.
8. This Agreement does not transfer any right, title, or interest in the Product to Customer except as specifically set forth herein.
9. Digico UK Ltd reserves the right to terminate this Agreement upon breach, in which event Customer shall thereafter only be authorised to use the Product to the extent that its contractual commitments to third parties require and then only where such commitments relate to use of the Product as authorised in the foregoing provisions of the Agreement.

**LIMITED WARRANTY** - Digico UK Ltd warrants for a period of 1 year from the date of purchase of the Product, the Product will reasonably execute its programming instructions when properly installed on the Target Platform. In the event that this Product fails to execute its programming instructions during the warranty period, the Customer's remedy shall be to return the Product to Digico UK Ltd for replacement or repair at Digico UK Ltd option. Digico UK Ltd makes no other express warranty, whether written or oral with respect of this Product.

**LIMITATION OF LIABILITY** - Except as otherwise expressly provided by law, (a) the remedies provided above are the Customer's sole and exclusive remedies and (b) Digico UK Ltd shall not be liable for any direct, indirect, special, incidental, or consequential damages (including lost profit whether based on warranty, contract, tort, or any other legal theory.)

This agreement is made under the Laws of England.

**LICENCE NO:** .....

**REGISTRATION DATE:** .....

# Contents

<b>1.1 Introduction .....</b>	<b>1-3</b>
<b>1.2 Manual Overview .....</b>	<b>1-3</b>
<b>1.3 Before You Start .....</b>	<b>1-4</b>
1.3.1 Worksurface Layout .....	1-4
1.3.2 Screen Assignment .....	1-4
1.3.3 Channel Banks .....	1-4
1.3.4 Using the Control Surface .....	1-5
1.3.5 The Assigned Channel .....	1-5
1.3.6 The Master Fader .....	1-6
1.3.7 Other Controls .....	1-6
1.3.8 Channel Types .....	1-7
<b>1.4 Hardware Configuration .....</b>	<b>1-8</b>
1.4.1 Connections .....	1-8
1.4.2 Audio I/O Panel .....	1-8
<b>1.5 Configuring a Session .....</b>	<b>1-11</b>
1.5.1 Session Structure .....	1-11
1.5.2 Assigning Faders to the Worksurface .....	1-12
<b>1.6 Saving and Loading Sessions .....</b>	<b>1-13</b>
1.6.3 Load Session .....	1-13
<b>1.7 Audio Sync .....</b>	<b>1-14</b>
<b>1.6 Routing Basics .....</b>	<b>1-15</b>
1.6.1 Selecting Inputs & Outputs .....	1-15
1.6.2 Ripple Channels .....	1-16
<b>1.7 Presets .....</b>	<b>1-17</b>
<b>1.8 Naming Channels and Busses .....</b>	<b>1-18</b>
<b>1.9 Channel Processing .....</b>	<b>1-19</b>
1.9.2 Dynamics .....	1-20
1.9.3 Auxiliaries .....	1-20
<b>1.10 The Matrix .....</b>	<b>1-21</b>
<b>1.11 Control Groups .....</b>	<b>1-22</b>
<b>1.12 Solo Setup .....</b>	<b>1-23</b>

<b>2.1 Introduction to Channel Types .....</b>	<b>2-2</b>
<b>2.2 Channel Input Setup - Common Elements .....</b>	<b>2-2</b>
2.2.1 Channel Strip Input Area .....	2-2
2.2.2 Channel Names .....	2-2
2.2.3 Channel Safes .....	2-3
2.2.4 Channel Settings .....	2-3
2.2.5 Channel Solos .....	2-5
<b>2.3 Channel Output and Inserts - Common Elements .....</b>	<b>2-6</b>
2.3.1 Channel Strip Output Area .....	2-6
2.3.2 Channel Strip Insert Areas .....	2-7
2.3.3 Console Output and Insert Routing .....	2-7
2.3.4 FX Presets .....	2-8
<b>2.4 Input Channel Specific Functions .....</b>	<b>2-10</b>
2.4.1 Trim and Track .....	2-10
2.4.2 Input Routing .....	2-10
2.4.3 Input Configuration .....	2-10
2.4.4 Output Routing .....	2-11
2.4.5 Aux Busses and Assignable Controls .....	2-11
2.4.6 Group Outputs .....	2-12
2.4.7 Direct Outputs .....	2-12
<b>2.5 Group Channels Specific Functions .....</b>	<b>2-13</b>
<b>2.6 Aux Channels Specific Functions .....</b>	<b>2-13</b>
<b>2.7 Matrix Channels Specific Functions .....</b>	<b>2-14</b>
<b>2.8 Channel Signal Processing .....</b>	<b>2-14</b>
2.8.1 Channel Filters .....	2-14
2.8.2 Channel EQ .....	2-14
2.8.3 Channel Dynamics .....	2-16
<b>2.9 LCD Functions .....</b>	<b>2-18</b>
2.9.1 Introduction to LCD Functions .....	2-18
2.9.2 Solo .....	2-18
2.9.3 Solo Choice .....	2-18
2.9.4 GANG .....	2-18
2.9.5 JOIN CG .....	2-19
2.9.6 Assign Faders .....	2-21
2.9.7 Unassign Faders .....	2-22
2.9.8 Copy Bank From .....	2-22
2.9.9 Copy Bank To .....	2-22
2.9.10 Clear Bank .....	2-22

<b>3.1 System Menu</b> .....	<b>3-2</b>
3.1.1 Diagnostics .....	3-2
3.1.2 Oscillator .....	3-2
3.1.3 Security .....	3-2
3.1.4 Clear Over Indicators .....	3-4
3.1.5 Overview Clear Screen .....	3-4
3.1.6 Keyboard Help .....	3-4
3.1.7 F10: Reset FX .....	3-4
3.1.8 F11: Reset Engine .....	3-4
3.1.9 F12: Reset Surfaces .....	3-4
3.1.10 Set Date & Time .....	3-4
3.1.11 Shutdown .....	3-4
<b>3.2 Files Menu</b> .....	<b>3-5</b>
3.2.1 Session Structure .....	3-5
3.2.2 Load Session .....	3-6
3.2.3 Save Session .....	3-7
3.2.4 Save As New File .....	3-7
3.2.5 Load Presets .....	3-8
3.2.6 Save Presets .....	3-8
3.2.7 Global Set To Defaults .....	3-9
3.2.8 Session Notes .....	3-9
3.2.9 Session Report .....	3-9
<b>3.3 Layout Menu</b> .....	<b>3-10</b>
3.3.1 Fader Banks .....	3-10
3.3.2 Channel List .....	3-11
3.3.3 Transport Control .....	3-11
<b>3.4 Snapshots Menu</b> .....	<b>3-12</b>
3.4.1 Storing a Snapshot .....	3-12
3.4.2 Recalling a Snapshot .....	3-12
3.4.3 Replacing a Snapshot .....	3-13
3.4.4 Editing Multiple Snapshots .....	3-13
3.4.5 Moving a Snapshot .....	3-13
3.4.6 Renaming a Snapshot .....	3-13
3.4.7 Renumbering Snapshots .....	3-13
3.4.8 Deleting a Snapshot .....	3-13
3.4.9 Snapshot Undo .....	3-14
3.4.10 Snapshot Notes .....	3-14
3.4.11 Snapshot Groups .....	3-14
3.4.12 Global Recall Scope .....	3-16
3.4.13 Individual Snapshot Recall Scope .....	3-16

3.4.14 Snapshot Crossfades .....	3-17
3.4.15 Snapshot Recall Times .....	3-18
3.4.16 Snapshots and MIDI .....	3-18
3.4.17 MIDI Devices .....	3-19
3.4.18 MIDI Program and MIDI List .....	3-20
3.4.19 Snapshots & GPOs .....	3-21
3.4.20 Snapshots & MTC .....	3-21
<b>3.5 Options .....</b>	<b>3-22</b>
3.5.1 Surface .....	3-22
3.5.2 Faders .....	3-23
3.5.3 Solo .....	3-23
3.5.4 Disable .....	3-24
3.5.5 Brightness .....	3-24
3.5.6 Meters .....	3-24
3.5.7 Session .....	3-25
3.5.8 Status .....	3-25
<b>3.6 Matrix Menu .....</b>	<b>3-27</b>
3.6.1 The Matrix Panel .....	3-27
<b>3.7 Graphic EQs Menu .....</b>	<b>3-28</b>
3.7.1 Graphic EQ Panel .....	3-28
3.7.2 Ganging Graphic EQs .....	3-28
3.7.3 Graphic EQ ALL Button .....	3-29
3.7.4 Graphic EQ Presets .....	3-29
<b>3.8 Solos Menu .....</b>	<b>3-30</b>
3.8.1 The Solo Panel .....	3-30
3.8.2 The No Solo Setup Display .....	3-31
3.8.3 Assigning Solo Busses to Worksurface Controls ...	3-32
3.8.4 Solo Outputs Routing .....	3-32
3.8.5 Headphone Outputs .....	3-32
<b>3.9 Setup Menu .....</b>	<b>3-33</b>
3.9.1 Audio I/O .....	3-33
3.9.2 Port Selection .....	3-33
3.9.3 Port Hardware Configuration .....	3-34
3.9.4 Port Control .....	3-34
3.9.5 The Socket Display .....	3-34
3.9.6 Socket Conforming .....	3-35
3.9.7 Group and Socket Names .....	3-35
3.9.8 Socket Options .....	3-35
3.9.9 Audio Sync .....	3-36



---

3.9.10 Timecode & Transport .....	3-36
3.9.11 Macros .....	3-36
3.9.12 The Macro Editor .....	3-37
3.9.13 Talkback .....	3-39
3.9.14 Talk To Auxes .....	3-40
<b>4.1 Network and Mirroring .....</b>	<b>4-2</b>
4.1.1 Network Configuration .....	4-2
4.1.2 Mirroring for the first time .....	4-2
<b>4.2 Multi-console Setups .....</b>	<b>4-4</b>
4.2.1 FOH and Monitors sharing a stage rack.....	4-4
<b>5.1 Troubleshooting .....</b>	<b>5-2</b>
5.1.1 Starting the console .....	5-2
5.1.2 Audio not passing on certain channels .....	5-2
5.1.3 Snapshots not recalling as expected .....	5-2
5.1.4 Snapshots not inserting as expected .....	5-2
5.1.5 Assigning console controls .....	5-2
5.1.6 Channels not appearing on the worksurface .....	5-2
5.1.7 No signal from the Solo buss .....	5-2
5.1.8 Signal from the Solo buss when nothing is soloed ..	5-3
5.1.9 External keyboard .....	5-3
5.1.10 Resetting the console .....	5-3
5.1.11 Talkback .....	5-3
5.1.12 Meters .....	5-3
5.1.13 Console lighting .....	5-3
5.1.14 Diagnostics .....	5-3



# **SD11 Operation Manual**

## **Chapter 1:**

### **Getting Started**



## 1.1 Introduction

The Digico SD11 consists of a rack-mountable worksurface with an onboard audio engine and a range of onboard inputs and outputs. This can be connected to multiple Input/Output Rack Units by CAT5 cable or MADI links which carry all the audio input and output signals.

The console worksurface can control 32 input channels (8 of which can be stereo), 8 VCAs, up to 12 mono or stereo busses, 8 Matrix inputs and outputs, 12 onboard graphic EQs and 4 onboard stereo effects.

There are 12 assignable faders, each with associated assignable encoders and switches, used to control elements displayed in the touchscreen.

Multiple console setups can provide:

Front of House and Monitoring with a shared stage rack and gain tracking.

Remote control of a console from a laptop computer.

Mirroring of two consoles for an expanded workspaces and audio engine redundancy



## 1.2 Manual Overview

- Chapter 1 provides an overview of the desk, and describes some of the basic operating principles which the user will need to understand in order to run the desk.
- Chapter 2 describes the functions of the different channel types.
- Chapter 3 describes the master section of the desk, focussing on the various menus in the Master screen.
- Chapter 4 describes network, mirroring and multi-console setups
- Chapter 5 is a guide to troubleshooting

The following typographical conventions are used in this manual:

**Bold** type is used to indicate that the text is an exact copy of the labelling either on a screen or on the worksurface.

An arrow bracket (>) is used to indicate a sequence of button pressing. For example, **Layout** > **Fader Banks** indicates that the **Fader Banks** button is accessed by first pressing the **Layout** button.

# Chapter 1

## 1.3 Before You Start

There are certain general operating principles and terms that should be understood before continuing to use this manual. Please read this chapter carefully before proceeding.

### 1.3.1 Worksurface Layout .....

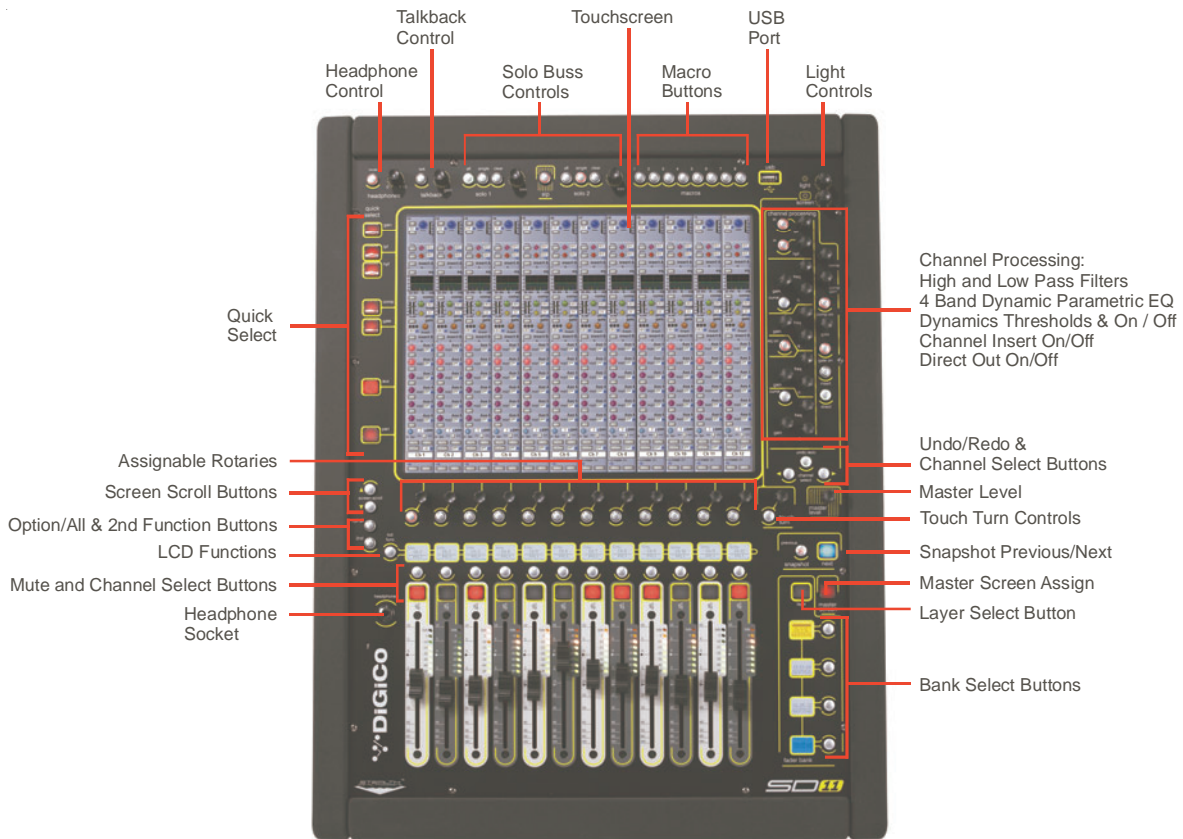

### 1.3.2 Screen Assignment .....

The SD11 has one central touchscreen which is used to access many of the consoles' functions. It displays either the in-channel controls for the selected fader bank, or the Master menus. Press the **master screen** button to the right of the faders to switch between these two displays.

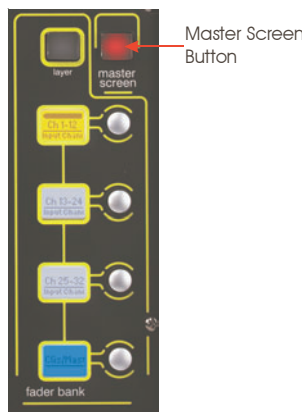

### 1.3.3 Channel Banks .....

The SD11's fader strips can be assigned to any of the console's fader banks. The SD11 has two layers, each with four banks of 12 faders. The active layer is selected using the **layer** button to the left of the **master screen** button, and the bank of channels which is currently active on the control surface are defined using the **fader bank** buttons below them (see diagram above).

The position of the banks on the worksurface is defined in the **Layout > Fader Banks** panel. By default, the Input channels are assigned to the first three banks of Layer 1, with Control Groups and Master fader are assigned to Layer 1 Bank 4, while the different output channels are assigned to Layer 2. These bank assignments can be customised by the user and saved in a session at any time.

### 1.3.4 Using the Control Surface .....

There are two main ways in which all of the functions of the SD11 are accessed:

1. The touchscreen display, which can be controlled directly using a finger, or by using the keyboard and mouse
2. The physical encoders, switches and faders.

**Note that when touching the screen directly, you may find it easier to use a finer point than your finger. However, in order to prevent damage to the screen, it is important that you only use devices specifically designed for touching screens (such as a pda stylus), and that you never press down hard on the screen.**

A number of functions can be accessed in different ways, allowing users to operate the console using whichever interface they prefer. This manual will describe accessing on-screen functions by touching the screen directly and not by using the mouse.

All of the physical controls found in the upper section are described in full within the relevant section of the manual and many require no further introduction. The Master screen has a row of grey buttons which are used to access a range of configuration displays. Pressing these buttons opens either a further drop-down sub-menu or a pop-up display. If a drop-down menu is opened, pressing on one of its entries will open a pop-up display. The buttons lighten to indicate that their sub-menu or pop-up display is open. A number of the buttons within each pop-up display generate further pop-ups.

The buttons within the pop-ups are coloured grey when their function is inactive, generally switching to a lighter shade of the pop-up background when their function is active. Pressing on a text box opens a numeric or QWERTY keypad which can be operated directly by pressing the screen or via the console's external keyboard.

Pop-ups are closed by pressing the box in the top right-hand corner of the pop-up, marked **CLOSE** or **CANCEL** (or by pressing **CAN** on keypad pop-ups).

To the right and below the touchscreen is a single encoder and switch marked Touch-Turn. This is used to access some of the rotary and switch controls within the Master screen. To assign the Touch-Turn encoder to a particular on-screen control, touch the pot to be assigned. You will notice that a coloured ring appears around the on-screen pot, indicating that it is assigned to the Touch-Turn encoder/switch.



### 1.3.5 The Assigned Channel .....

One of the channels in the Channel Strip panel is displayed in gold, indicating that it is currently the Assigned Channel. This means that it has been assigned to the worksurface controls and can be configured in detail, as described below. To Assign a channel, touch anywhere in the channel on the screen (except the Aux Send area).

Once a channel is Assigned, all of the controls for that channel which are not displayed within the channel strip itself can be accessed via secondary pop-ups, displayed by touching inside the relevant area of the channel. These pop-ups include controls such as input and output routing and signal processing parameters.

A number of the physical rotary encoders on the control surface can be assigned to different on-screen pots. In order to ensure that it is clear which function is assigned to which encoder, the assigned on-screen pot will have a coloured ring around it.

The twelve encoders and buttons immediately below the touchscreen refer to the channels with which they are aligned:

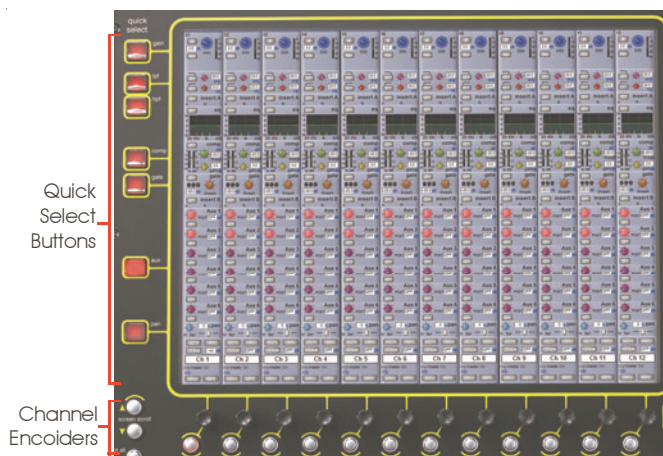

Pressing one of the **Quick Select** buttons on the left of the screen will assign the selected function to the below the screen.

# Chapter 1

Six aux sends can be displayed in the Channel Strip panel at any one time. If more than six aux sends have been created in the session, the scroll button outside the bottom left-hand corner of the screen can be used to scroll the display through the remaining auxiliaries.

The controls to the right of the Channel Strip panel allow the Assigned channel to be adjusted:



## 1.3.6 The Master Fader .....

The master group output, which is the lowest stereo group output by default, can be controlled using the **master level** pot next to the **touch turn** encoder:



## 1.3.7 Other Controls .....



Below-left of the screen, there are two modifier buttons: When pressed, the **2nd function** button allows access to different parameters:

- 1) Stereo Aux Pan and Pre/Post switching
- 2) Hard Mute of a channel
- 3) Fine adjustment of Delay settings on output channels

The **Option/All** button has 2 main functions:

- 1) When pressed and released, any channel that is a member of a gang will be temporarily isolated from that gang.
- 2) When pressed and held, any parameter that is adjusted on a single channel will also be adjusted in the same way on all of the channels in that bank



### 1.3.8 Channel Types .....

The signal flow of the SD11 is best understood in terms of the four channel types contained within it, shown below. Each channel type offers full signal processing capabilities. As a summary, the four channel types are as follows:

- Input channels bring signals into the console to be mixed and sent to aux and group busses.
- Aux channels send a variety of mixes of the Input channels to the Aux outputs, mainly for use as monitor mixes and FX sends.
- Group channels mix groups of input channels together, to feed the buss outputs or the output matrix.
- Matrix channels send the outputs of the matrix to the console's main outputs (Optionally).

The Group channels, Aux channels and Matrix channels are all referred to as output channels. While the Aux and Matrix channels are the channel types most commonly routed to outputs, all four channel types can be routed directly to outputs.

*Note that the TB channel is its own channel type. It is described in the Master Screen section of the manual.*

Channels are laid out in banks of 12 on the console worksurface and can be identified by their colour: Light-blue for Input channels, red for Group channels, purple for Aux channels and blue-green for Matrix channels.

By default, the Input Channels are assigned to the banks in Layer 1 (along with Control Groups) and the output channels (Groups, Auxes and Matrices) are assigned to the banks in Layer 2. These bank assignments can be customised by the user and saved in a session at any time.

The controls on each different type of output channel are similar, but an input channel has a number of additional features.

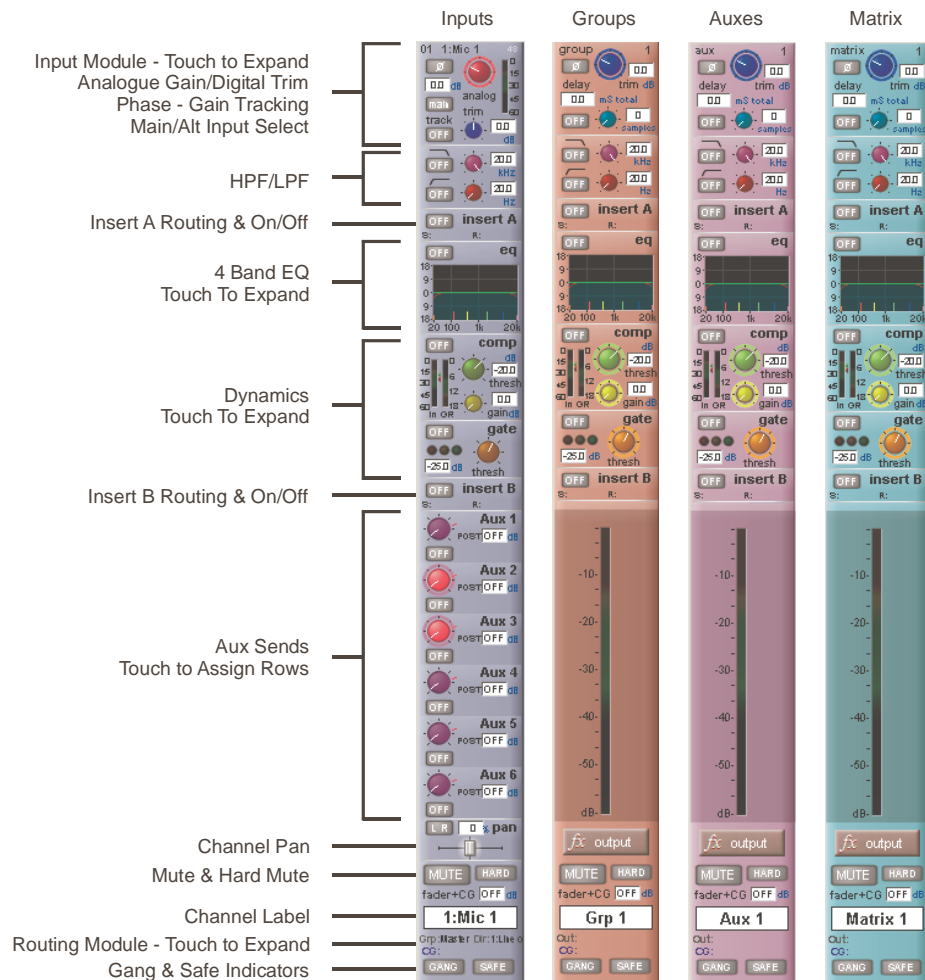

## 1.4 Hardware Configuration

### 1.4.1 Connections .....

Detailed information on the various systems of connection is provided in the relevant Appendix but the following diagram provides an overview of a single console/ rack setup. The racks may have dual redundant power supplies and both should be switched on at all times. After switching on the console the software will be launched automatically and the state of the worksurface and settings should be the same as when it was last Shut Down.

All connections should be made before switching on the console and racks. The SD11 rear panel provides 16 analogue ins, 8 analogue outs, and 1 AES I/O, with additional I/O supplied in the form of a remote D-Rack which has 32 analogue inputs and 8 analogue outputs as standard. This rack is connected to the worksurface by a 75M SSTP CAT5e cable.

There is also a pair of standard BNC MADI connectors (MADI IN & OUT) which can be connected to any of the range of DiGiCo stage racks (DiGiRack, SDRack, MaDiRack or MiNiRack) with 75Ohm coaxial cables. This MADI port could also be used to connect to a MADI equipped recorder.

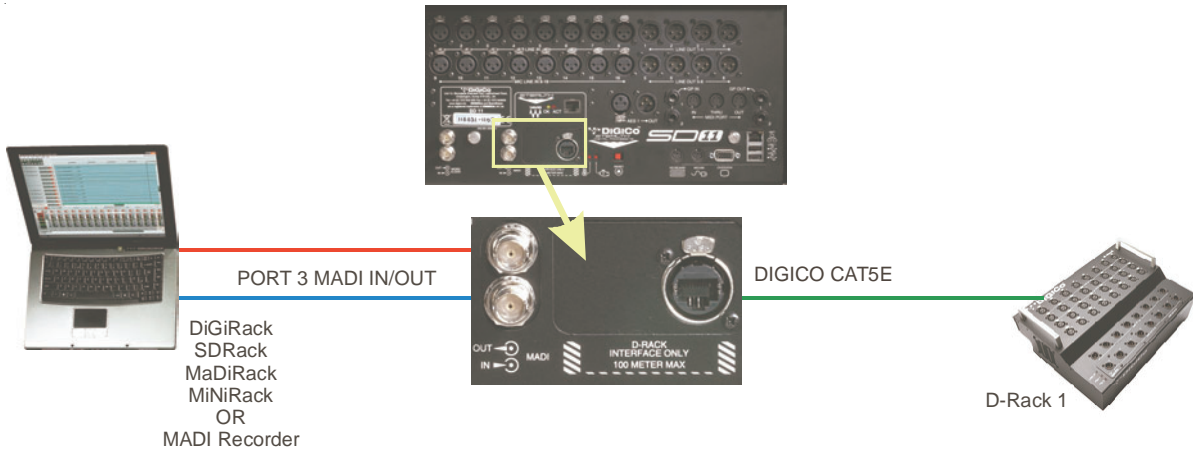

### 1.4.2 Audio I/O Panel .....

The Audio I/O window is used to configure the physical I/O connected to the SD11, including configuring and naming the sockets of the cards installed in racks, and the setting of Pads and phantom power.

Local I/O : The SD11 provides local audio I/O in the rear of the console. These operate independently of connected racks..

To access the SD11 Audio I/O Setup touch **Setup>Audio I/O** on the Master Screen

The Audio I/O window that opens is divided up into the following sections:

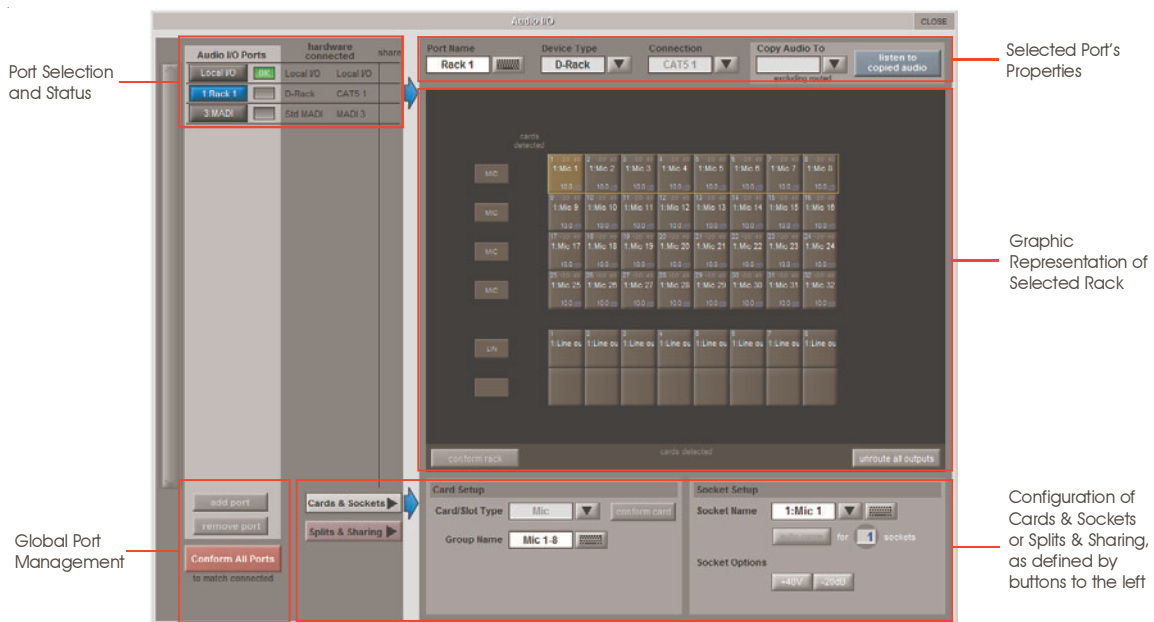

The top-left corner of the window shows the ports. Each port relates to an available physical audio connection (Local IO, D-Rack or MADI Port). Ports can be added and removed using the buttons in the bottom-left corner of the window.

The top-right area contains the controls relating to specific ports. When a port is selected, this section changes to reflect the status of the selected port, and allows its configuration to be changed as required.

Most of the right-hand section of the panel consists of a graphical representation of the rack configuration connected to the selected port. Depending on the port selected, the graphic will change, showing the available physical I/O. Each small “square” on the image represents a single physical audio connection or socket, with these arranged in columns or rows, representing I/O cards in racks, or the local I/O on the back of the console.

The section below the graphical rack picture allows configuration of either the cards or slots and sockets (including custom naming, phantom power and pad selection), or card splits and control sharing. The **Cards & Sockets** and **Splits & Sharing** buttons define which elements are displayed for configuration.

The local I/O configuration is fixed, so no hardware changes are possible. You can, however, change the Port Name, the Group Names and the Socket Names (the name of each physical connector on a card).

## Rack Connections

With a Rack selected in the left hand port selection list, the window will change to look something like the image below, depending on the cards installed in the connected rack. The graphic shows the 6 available cards/slots, 4 input & 2 output.

**NOTE:** For a D-Rack the only configurable (non fixed) slot is the second output slot which can either be an analogue or AES output card.

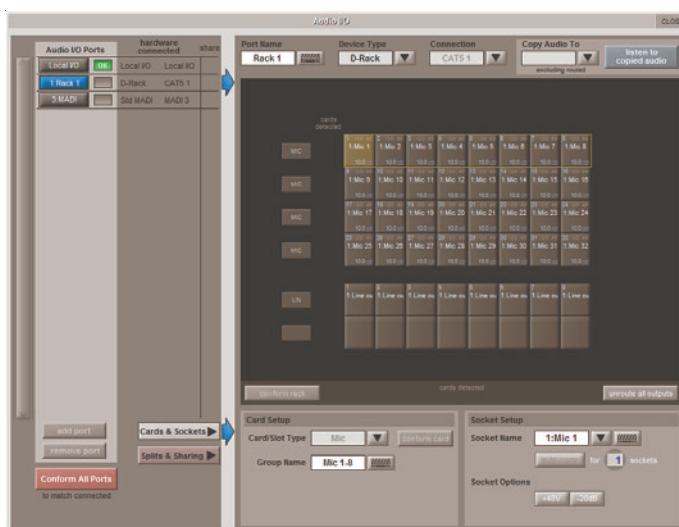

In order to use the rack, the on-screen contents of the rack must match the cards physically installed in the rack connected. There are two ways of achieving this:

### Manual Conforming of Rack:

Select each card (column) and manually select the appropriate card in the Card/Slot Type drop down menu in the lower section of the window (displayed when the **Cards & Sockets** button towards the bottom-left is selected). Once the correct card type is selected, the Label at the bottom the selected card will turn green, indicating the card type matches the card installed in the rack. If the Card Type name is Red, then there is a mismatch, and the error should be corrected by selecting the correct card type.

### Automatic Conforming:

There are three levels of automatic conforming:

- globally, using the red **Conform All Ports** button in the bottom left of the window;
- on a rack-by-rack basis, using the **conform rack** button just below the rack view section of the window;
- on a card-by-card basis, by selecting a socket from the card in the graphical display and using the **conform card** button next to the Card/Slot type button selector in the lower section of the window. (Note that the **Cards & Sockets** button towards the bottom-left should be selected)

Pressing any of these buttons will correctly select the card types for the range in question. Once complete, all of the Card Labels beneath each slot should turn green.

### Copying Audio and Listening to Copied Audio (MADI Recorder Setup)

Audio from a D-Rack can be copied to the MADI Port Output by selecting the incoming Port in the Ports list and using the **Copy Audio To** drop down menu. For example, if you want to copy the D-Rack Audio Inputs to a recorder connected over MADI, select **Rack 1** in the ports list and then select **MADI** from the **Copy Audio To** drop down menu. The 32 inputs on Rack 1 will be copied to the SD11 MADI output.

In addition, by connecting the recorder's MADI Output to the SD11 MADI Input, the playback can be monitored in the same channels as the original source material. Just press the **Listen To Copied Audio** button to monitor playback and press it again to return to monitoring the live sources from the rack.

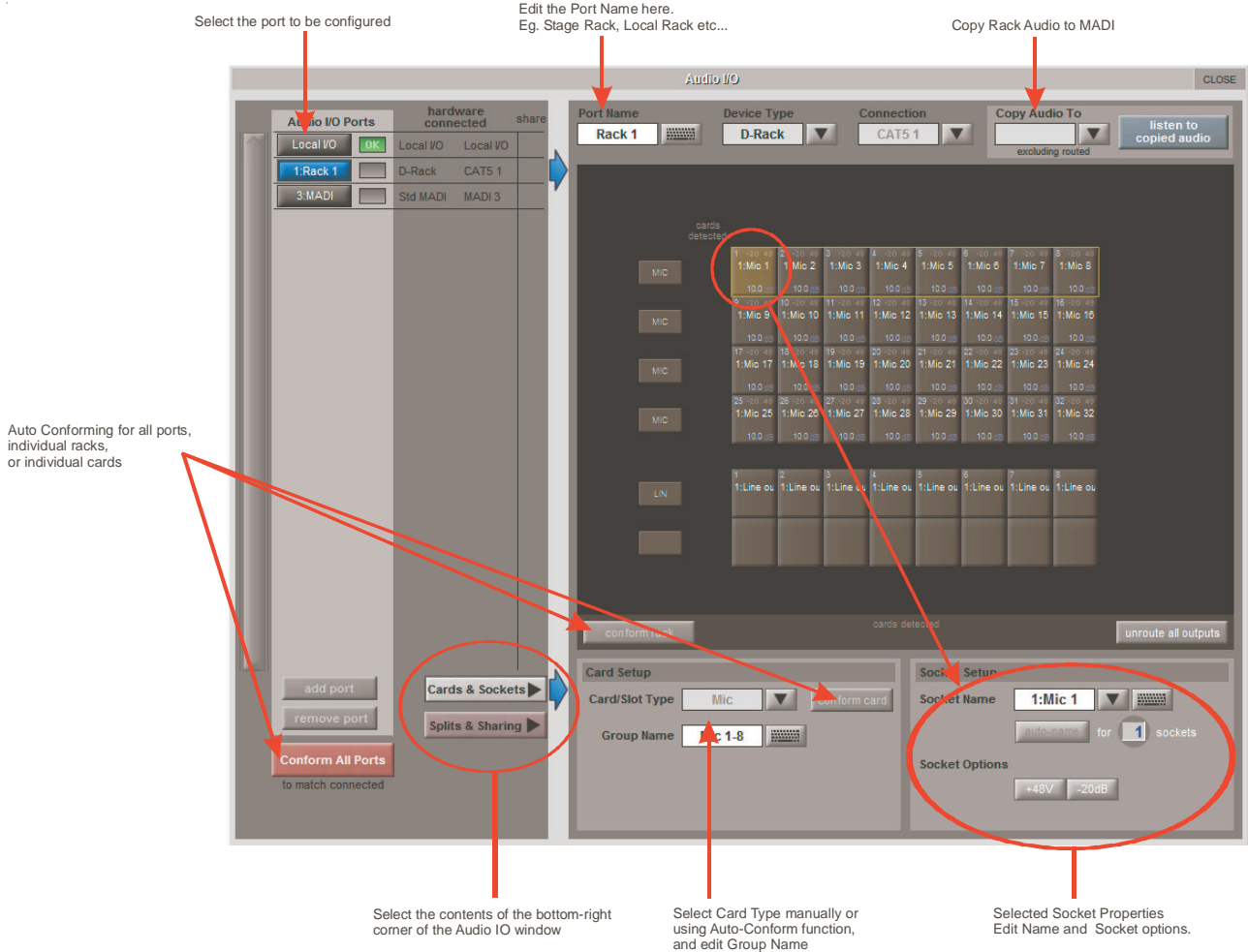

## Standard MADI Connections

If you have a standard MADI connection (not a DiGiCo Rack) to your SD11, you can set it to display the MADI with generic signal names, i.e. MADI 1, MADI 2.. etc. through to MADI 56 instead of the usual rack style names. The naming does not affect the signal, but makes routing signals easier.

## Console to Console routing

If two DiGiCo consoles are connected together using MADI, it is possible to route audio between them. The Port that is connected to the second console should be defined as a Standard MADI Connection.

## Unrouting All Outputs

All outputs to the selected port can be unrouted at once by pressing the **unroute all outputs** button below the cards graphic and selecting **yes** in the warning pop-up which appears. "Copied" audio is not unrouted by this action.

*Note that this will cancel all routing created in the channel screens and cannot be undone.*

## Splits & Sharing

In a multi-console system where Racks are connected with MADI and shared between two DiGiCo Consoles, only one of the consoles can take control of the rack, with respect to Gain, Phantom Power and Pads. To overcome this, it is possible to place the SD11 into one of 3 states of operation; Isolate, Receive Only or Full Control.

Sharing is configured in the bottom right-hand corner of the window when the **Splits & Sharing** button is selected:

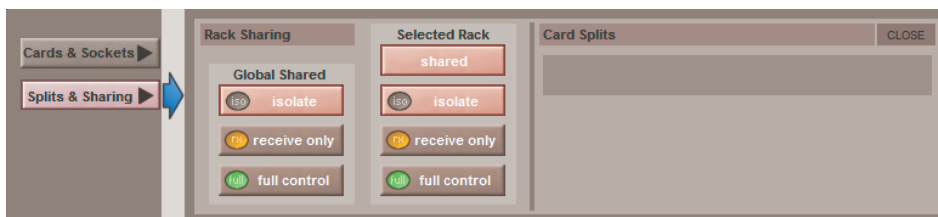

These three states can be set individually in the right column), on a per-rack basis (middle column), or globally for all shared racks (left column).

**Isolate** : The SD11 will not communicate with the rack and therefore any adjustment of input gain or +48V switch will have no effect on the rack settings

**Receive Only** : The SD11 will receive the rack's existing settings but will not be able to control the gain etc on the racks.

**Full Control** : The SD11 will send its settings to the racks and change them accordingly.

## 1.5 Configuring a Session

The SD11 has a default setup which means that the new user need not get involved in configuring the desk at this stage. However, here is a brief overview of how the different displays are used in putting together a session. Each of the master displays introduced below are described fully within the rest of the manual.

The **Setup > Audio IO** display is used to configure the physical I/O connected to the SD11, including configuring and naming the sockets of the option cards installed in racks, and the setting of pads and phantom power. (See previous section)

The **File > Session Structure** display is used for configuring how the console's audio engine is to be divided between channel types, and where the format of the channels is defined.

The **Session Structure** display can be used to automatically assign the channels to the worksurface. However, channels can also be manually added to the worksurface using the **Layout > Channel List** display.

### 1.5.1 Session Structure .....

When starting a new session, it is important to decide how many of each type of buss is required. While changes to session structure can be made once a session has been started, it is best to try and set these parameters before configuring the session. The structure will set the number and type of aux and group channels and allow you to choose which parts of the new session will be cleared and reset. There is also an option to automatically route the inputs and outputs from channel types that you have opted to clear.

To adjust any of the channel allocations, touch on the associated channel count box, and either enter a number using the pop-up number keypad, or adjust using the assigned touchturn controller.

The maximum number of Aux and Group channels available is 12 mono or stereo, in addition to a stereo or LCR master buss. As you increase the number that you require you will see the resources available decreasing accordingly in the number boxes at the bottom of the panel.

**Note - Pressing the Default All button followed by the Restructure button will automatically configure a new session with the first 32 rack inputs routed to input channels 1-32 and the Master Buss routed to Local outputs 1 & 2 and also to Rack 1 outputs 1 & 2. All input channels will be routed to the Master Buss and the console headphones will be fed by the Master Buss when nothing else is soloed.**

The default configuration is :

- 32 input channels (Fixed) of which 8 can be stereo
- 3 Mono Aux busses & 3 Stereo Aux busses (Adjustable)
- 3 Mono Group busses & 3 Stereo Group busses (Adjustable)
- 8 Matrix Inputs and 8 Matrix Outputs (Fixed)
- 8 Control Groups (Fixed)
- 1 Stereo or LCR Master Buss
- 2 Mono, Stereo or LCR Solo Busses (Fixed)

The screenshot shows the 'Session Structure' configuration interface. Annotations include:

- Touch numbers to edit with pop-up keypad or touchturn:** Points to the channel count boxes for input channels, aux busses, and group busses.
- Enter Session title:** Points to the 'session title' input field.
- Set number and type of Aux:** Points to the 'aux busses' section, specifically the Mono and Stereo count boxes.
- Set number and type of Group:** Points to the 'group busses' section, specifically the Mono and Stereo count boxes.
- Automatically route inputs/outputs when using the Clear function:** Points to the 'clear all' buttons for matrix inputs and outputs.
- Create a default session with flat parameters and basic routing:** Points to the 'DEFAULT ALL' button.
- Option to Clear parts of the session when restructuring:** Points to the 'clear snapshots', 'clear automation', 'clear macros', and 'clear all presets' buttons.
- Total number of unallocated processing:** Points to the 'spare: channel processing' box (value 1).
- Total number of spare busses:** Points to the 'busses' box (value 1).



# Chapter 1

**Clear All Buttons** : When changing routing, you have the option of clearing any non-default routing or processing (EQ, dynamics etc) from the channels in the session. This is especially useful when restructuring an existing session to make a new session. The clear snapshots, clear automation and clear macro's perform similar operations.

**Rebuild Banks** : When changing the session structure, there are two possible scenarios. If you restructure the session without rebuilding banks, any additional channels you have allocated are not "placed" on the worksurface, and need to be manually assigned to faders. If however, you restructure a session with Rebuild Banks enabled, the worksurface will be built with all channels available on the worksurface.

**Aux Sends and Direct Sends** : By toggling the state of the Aux Sends and Direct Sends Buttons in the Input Channels section, it is possible to change the default operation of the Aux Sends and Direct Sends. These functions toggle between "Post Fader", "Pre-Fader" and "Pre-Mute". These buttons can only be used in conjunction with the **clear all** function.

**Auto-Route** : The Auto-route functions automatically routes consecutive inputs for input channels, and consecutive outputs for busses. For example, auto-routing 32 inputs will route the first physical input (eg 1: Mic 1) to input channel 1, the second physical input (1: Mic 2) to input channel 2... until you either run out of inputs or channels. Auto-routes are as follows :

Input Channels auto-route with physical inputs

Aux, Group and Matrix Channels auto route to physical outputs

Matrix Inputs auto-route with group outputs

**NOTE** : Auto-Routing can only be used in conjunction with the "Clear All" button.

## 1.5.2 Assigning Faders to the Worksurface .....

If, after a Session Restructure where the Rebuild Banks button was not pressed, you find that newly created channels do not appear on the worksurface, open the **Layout>Channel List** panel on the Master screen and you will see a full list of all input and output channels that are present in the session.

Channels can be assigned to the worksurface individually (in order to create custom banks of mixed channel formats) or as complete banks.

First, select a bank and press the **LCD Function** button.

To create a custom bank, press the Channel Select button below the display labelled **Assign Faders** followed by the LCD button on the fader to be assigned (or select multiple faders to assign consecutive channels).

To create complete a complete bank, press the Channel Select button labelled **Copy Bank From**.

Having selected the faders or bank, press the first channel that you wish to assign on the **Layout/Channel List** list on the Master screen. Consecutive channels will be assigned to the selected worksurface faders.

Now press the LCD Function button again and return to the standard mode by pressing the LCD button labelled **Solo**

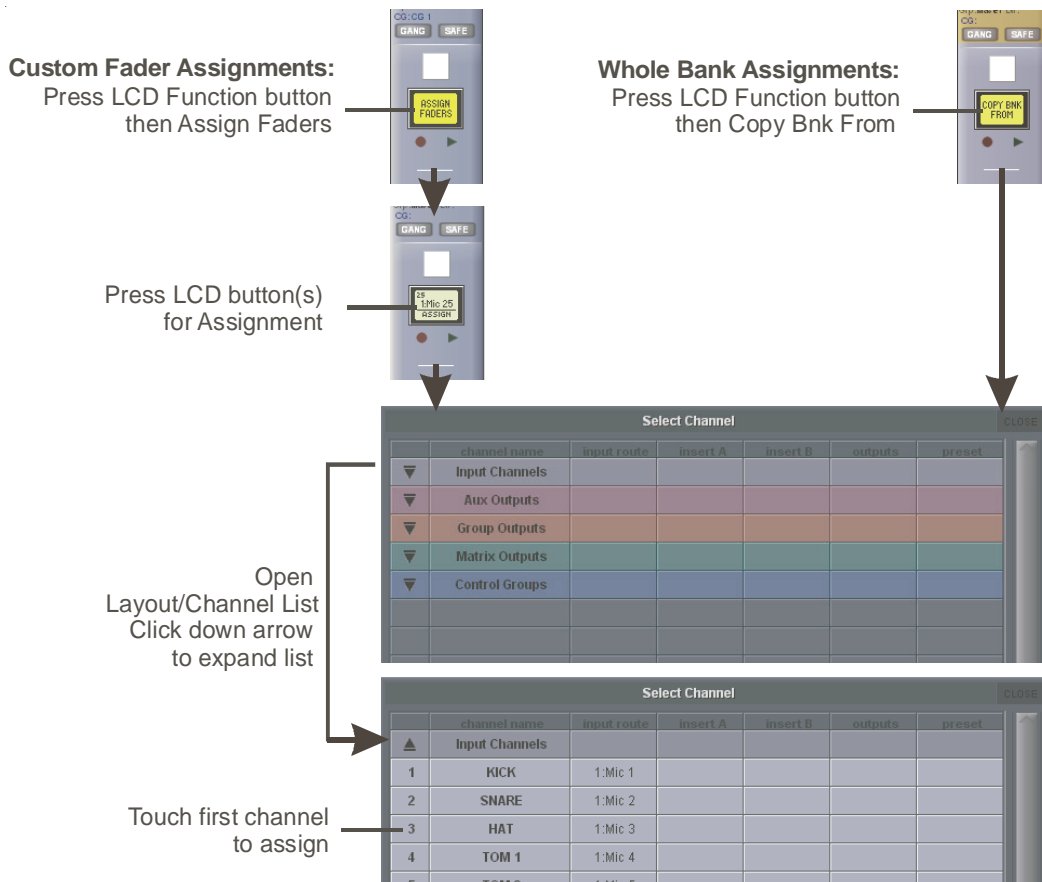

## 1.6 Saving and Loading Sessions

### 1.6.1 Save As New File .....

When you change the configuration of the a session you should save it to the console's flash drive under a new filename. If the Save Session panel has not appeared automatically after a session restructure then touch the **Files** button on the Master screen and then press **Save As New File**.  
 Select the destination drive (Internal or Removable) and file path and then enter a new file name and description for the file - then press the **Save** button.

**Note: If you touch a session name on the existing list, this name will automatically be selected as the new file name and touching Save will overwrite the old file.**

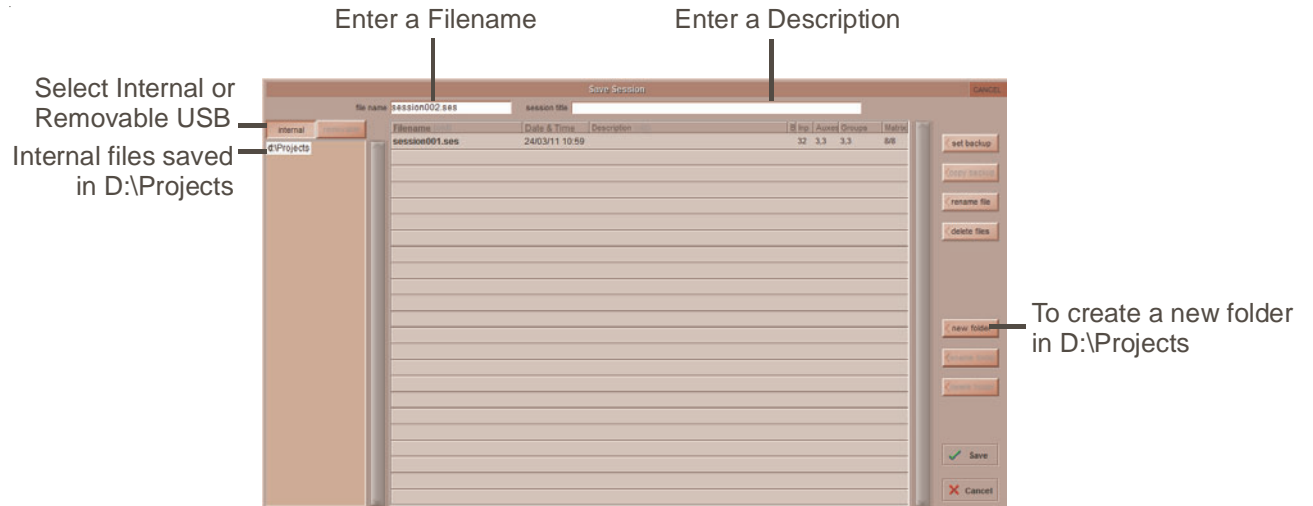

### 1.6.2 Save Session .....

This button which is found above the **Save As New File** button will save the existing session in the same location and under the same file name as it was previously saved or loaded from. It therefore serves as a "**Quick Save**" option to update an existing session.  
**Remember that this function will overwrite your last saved version.**  
 If you wish to save the session under a new name use the **Files** menu button and select **Save As New File** (See above).

### 1.6.3 Load Session .....

To load a previously saved session:  
 Touch the **Files** button on the Master screen and then press **Load Session**.  
 Select the source drive (Internal or Removable) and the required file from the list - then press the **Load** button.

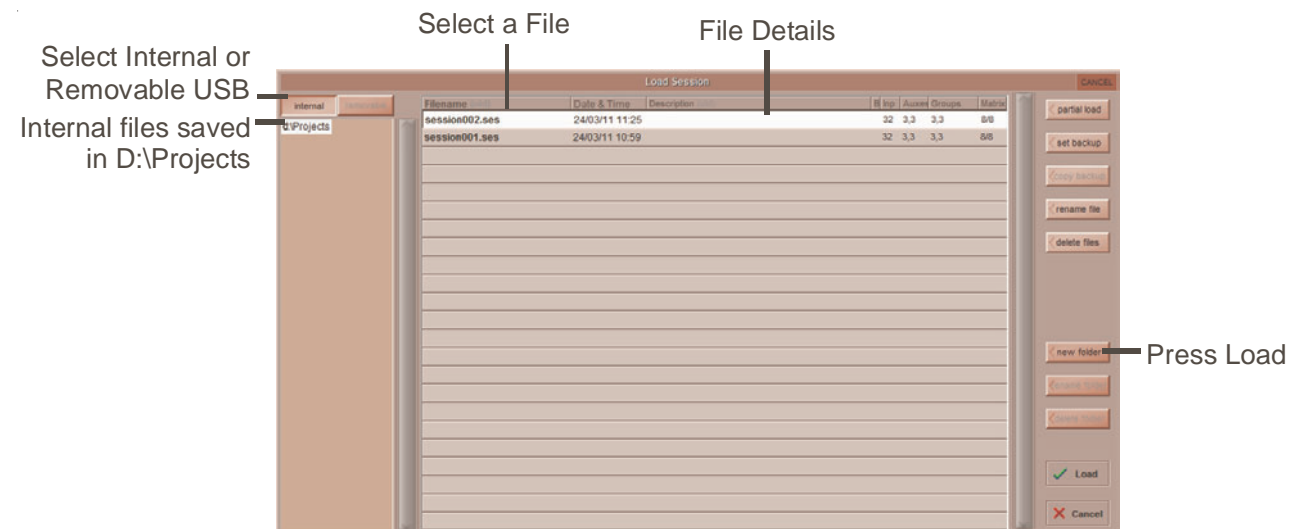

## 1.7 Audio Sync

The SD11 operates a Sample Rate of 48000Hz (48kHz). By default, it is set to clock internally (as a Master). The **Audio Synchronisation** panel allows you to set the console to be clocked externally. To open the **Audio Synchronisation** Panel, touch the **Setup** Menu button, followed by **Audio Sync**:

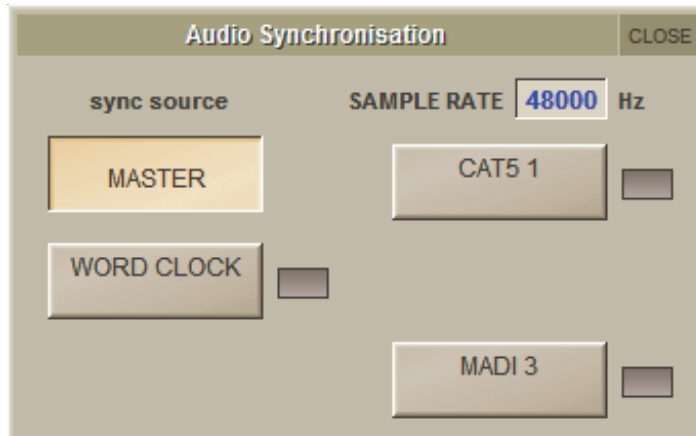

The SD11 will clock from the back panel Word Clock connection, or from equipment connected via CAT 5 or MADI.

**Note** : When a valid clock is detected on an external sync input, the corresponding Green OK box will light, even if that input is not selected as the clock source for the SD11.





## 1.6 Routing Basics

### 1.6.1 Selecting Inputs & Outputs .....

All channel input, output, insert send and insert return routing is done via routing displays, accessed via the dark grey routing buttons in the channel **Setup** and **Output** displays (shown below for an Input channel's input).

To access Channel Input Setup, touch the top of an input channel display on the touchscreen.

To access Channel Output Setup, touch the bottom of any channel type's display on the touchscreen.

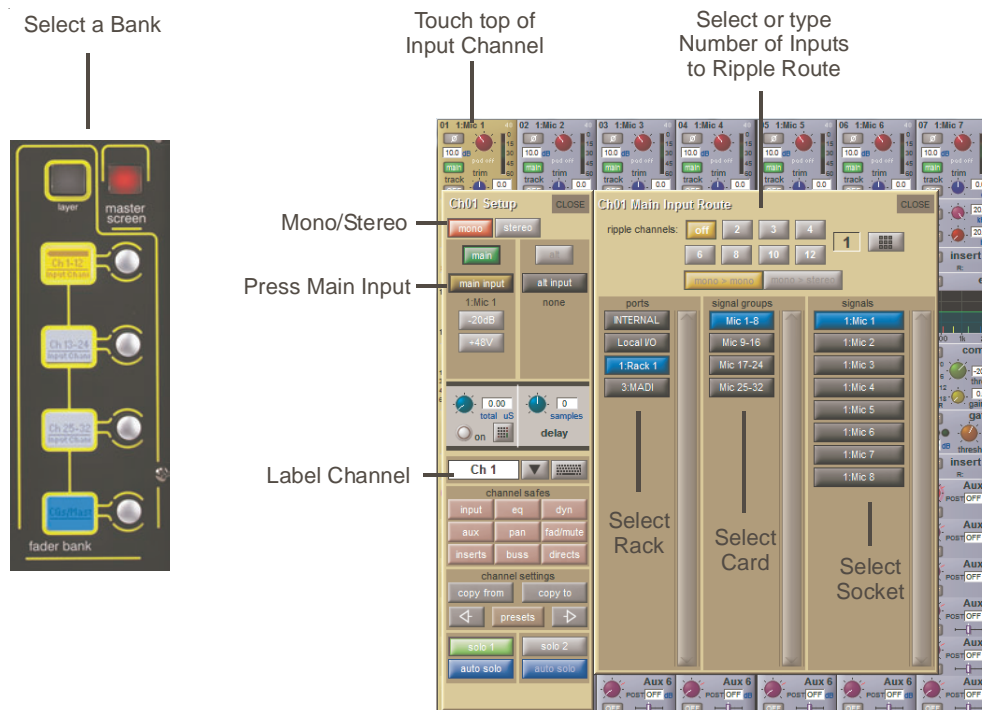

Within each display, there are three columns containing three levels of routing selection:

- The left-hand column contains the available **ports** within which the desired input or output might be located;
- The middle column, **signal groups**, then shows the available groups of inputs or outputs within that port;
- The right-hand column, **signals**, then displays the individual inputs or outputs available within that signal group.

The boxes in each column are lit blue to indicate that they are currently selected. If there is already a routing assigned within the display, the **port** and **signal group** columns containing the current assignment will be half-lit.

Each output can only have one channel routed to it. The outputs that are currently in use by another channel display in blue text. If you attempt to route a different channel to an output which is already in use, a confirmation box appears, indicating which channel is already using it, and warning that continuing with the action will cause the old channel to be derouted from this output. Press **Yes** to proceed, **No** to cancel.

**Note that when routing direct outs from Input channels or outputs from output channels, any number of available signals can be selected. A new route selection will therefore be added to previous selections in these cases. However, inputs, insert sends and insert returns can only route to/from one signal (in the case of mono channels) or two signals (in the case of stereo channels). A new route selection will therefore result in the previous selection being lost for inputs and insert sends and returns.**

For stereo channels, left and right routes are presumed to be consecutive: When routing stereo signals, select the left route, and the next signal in the list will be automatically selected as the right route. If the last signal in a signal group or port is selected as the left route, the first signal in the following signal group or port will be selected as the right route.

For input and insert return routing, the **INTERNAL** port provides the following signal groups:

- Misc:** The oscillator, white and pink noise generators.
- Graphic EQs:** The outputs of the SD11's internal graphic EQ's.
- Effects:** The outputs of any effects sends that have been created
- Channels:** The direct outputs from the other input channels
- Groups:** The outputs of the group busses
- Auxes:** The outputs of the auxiliary busses.
- Matrix:** The outputs of the Matrix.

# Chapter 1

---

*Note: The outputs for the channel being routed are locked out of the signal list.*

*Note also that the console views all routes as a single list. Therefore, if the left signal is connected to the last signal in a port, the right signal, will be automatically connected to the first signal of the next port, regardless of port type.*

For output and insert send routing, the **INTERNAL** port provides access to the inputs of the SD11's Graphic EQ's, and the inputs to any effects that have been created.

The **0:Local I/O** port contains a list of the inputs or outputs found directly on the SD11's back panel.

The **Rack** ports contain all of the inputs or outputs available within the remote I/O racks, as defined in the **Audio I/O** display

Once a route has been selected, its name will appear below the routing button in the **Setup** or **Outputs** display.

Whenever a route is created, metering and additional controls are made available below the routing button. These controls are dependant on the type of route created, and are described in detail within Chapter 2 where necessary:

Local Mic input routed to an input or insert return:	<b>48V</b> button for remote control of phantom power, <b>-20dB</b> input pad
D-Rack Mic routed to a mono input or insert return:	<b>48V</b> button and <b>-20dB</b> pad
D-Rack Mic or Local Mic Input routed to a stereo input:	<b>48V</b> button, <b>-20dB</b> pad, <b>m-s</b> decode, <b>width</b> , <b>balance</b> and component routing controls.
Mic pre-amp routed to an insert return:	<b>48V</b> button, <b>-20dB</b> pad, phase reverse button and gain trim.
Output routed to a console output:	<b>-10db</b> pad (rack out only), <b>on</b> button for switching the send on/off, gain trim and channel send point selector which cycles between: <b>pre-F</b> Pre-fader, <b>post</b> Post-fader <b>pre-M</b> Pre-mute (and pre-fader)
Insert send routed to a console output:	<b>-10db</b> pad (rack out only), <b>on</b> button for switching the send on/off, and gain trim.
Insert send routed to a graphic EQ:	an <b>on</b> button for switching the send on/off
Output routed to a graphic EQ:	no additional control.

Buttons become ringed in either red or green to indicate that they are on.

## 1.6.2 Ripple Channels .....

The **ripple channels** function, located at the top of the route display, allows consecutive channel routes to follow the routing of the current display incrementally. For example, Channels 1 to 8 direct outputs can be routed to Rack 1 > Line outs 1 to 8 respectively by routing Channel 1's direct out to Rack 1 > Line out 1 and allowing the **ripple channels** function to route Channels 2-8 automatically.

The number of channels to be rippled is defined either by selecting the appropriate grey numbered button, or by selecting the keyboard button to the right of the numbered buttons, typing the required number of channels (8 in the example above) into the numeric keypad which appears, and pressing **OK**. Once you have configured the **ripple channels** function, any routing action will also effect the appropriate number of channels above the channel being routed.

The **ripple channels** function treats stereo channels as two channels. In other words, if Channel 2 in the above example is stereo, the **ripple channels** function will route Channel 1 to Line out 1, Channel 2 Left and Right to Line outs 2 and 3, Channel 3 to Line out 4 etc.

## 1.7 Presets

Presets are used for storing and recalling settings for channels, fx units, graphic EQs and the matrix. While each preset functions slightly differently, this section provides a basic understanding of how to use the various preset displays:



The left-hand column of a preset display contains the available **groups** of presets, and touching one of these groups brings up the list of presets within that group in the column to its right (**name**). The columns to the right of the preset name displays the number of channels whose settings are included in the preset (**chs**) (Channel and Matrix presets only), the date and time it was created or updated (**notes**), and whether or not it is locked (**lock**).

**Note that a presets display will only list presets of the relevant type.**

To recall a preset, touch the name of the **group** containing the preset you wish to recall, and then touch the preset's name. The **recall scope** buttons at the bottom of the some preset displays allow you to select which elements are recalled and which elements remain unchanged. The buttons are included in the recall when they are lit.

To save the current settings as a new preset, touch the group in which you want the preset to be stored and press the **new** button. The new preset is automatically named according to the preset type. To alter the preset's name, type the new name using the keyboard display that appears (or the external keyboard) then, if relevant, touch and edit the number of channels' settings that you want to store in the preset (the default is one channel). Now touch **OK**.

**Note that pressing CAN in the keyboard display will cancel the display but create the new preset with its default name.**

To save the settings as an update of a previous preset, press **update**, touch the preset you wish to overwrite, and press **Yes** in the confirmation display which appears.

**Note that when updating a previous preset, failing to press update will result in the preset you wish to overwrite being recalled, and the settings to be saved being lost.**

To create a new group of presets, press **new group**. A new group will be created, called **group n**, where **n** is the next available preset group number. To alter the group's name, type the new name using the keyboard display that appears (or the external keyboard) and touch **OK**.

**Note that pressing CAN in the keyboard display will cancel the display but create the new group with its default name.**

The **edit name** button allows preset names and group names to be edited, and the preset to be locked, preventing them from being edited, overwritten, or deleted. The button lightens to indicate that it is active. To edit a preset's name, make sure the preset is unlocked (see below), activate the **edit name** button and touch the preset's name. Type the new name in the keyboard display and press **OK**. To edit a preset group name, activate the **edit name** button and touch the group name. Type the new name in the keyboard display and press **OK**.

To lock the preset, activate the **edit name** button and touch the preset's **lock** column. A grey padlock appears, indicating that the preset is now locked. Touching the lock again with **edit name** active unlocks the preset.

To delete a preset, press **delete**, touch the preset to be deleted, and press **confirm**. To delete a consecutive range of presets, press **delete** followed by **select range**, touch the first and last preset to be deleted and press **confirm**. To delete one preset, or a nonconsecutive range, touch each preset to be deleted and press **confirm**. To delete an entire group of presets, press **delete** followed by **select all**, then press **confirm**.

# Chapter 1

## 1.8 Naming Channels and Busses

A large number of elements within the SD11 can be custom named. Access to the naming facility is via black and white text boxes with down arrow and keyboard buttons to their right, such as shown here:



To create a name manually, touch the text box or the keyboard symbol to its right to bring up a QWERTY keyboard display. This keyboard includes standard **Caps**, **Shift** and **Delete** functions, as well as **Cut**, **Copy** and **Paste** functions which can be used to move name text between channels. The arrow buttons in the bottom left-hand corner of the keyboard display move the cursor within the text box. Create the new name, either using the on-screen keyboard display or the external keyboard, and press **OK**. To close the keyboard display without changing the name, press **CAN**. To move the keyboard display to the following channel, press **Next** (or **TAB** on the external keyboard).

The **Channel Name** display enables commonly used words to be inserted quickly without the use of the keyboard. This facility is available not only when naming channels but also when naming other elements. To open the **Channel Name** display, touch the down arrow immediately to the right of the **Setup** display's channel name text box.

CAPS	Initial Cap	custom	edit	Channel Name								CLEAR	CLOSE	
				12 string	bot	crash	girls	keys	mic	piano	snare	tom		0
				ac	boys	di	glock	kick	mid	princ	soprano	top		1
				acoustic	brass	direct	gong	kit	midi	prog	spare	track		2
				alto	bv	double	gtr	ldr	mono	rack	stage	trombone		3
				audience	cd	drums	guitar	lead	mp3	rear	stalls	trumpet		4
				backing	cello	far	hand	left	near	reverb	strings	vola		5
				backup	choir	feed	harmony	lo	noise	rhythm	sub	volin		6
				band	chorus	fill	hat	loops	o/h	ride	surr	vocal		7
				baritone	circle	floor	head	madl	oboe	right	sync	vxx		8
				bass	clarinet	flute	hi	main	opto	sax	synth	wind		9
				bongo	click	front	hi-hat	master	organ	seq	tenor	woodwind		L
				booth	change	fx	humi	mid	perc	side	timpani	xylophntr		R

Touching any word from the display inserts that word into the channel name text box. Further words can then be added to the channel name in the same way, divided by a single space. Numeric and L/R identifiers can be added from the column down the right-hand edge of the display. Text can be entered in CAPS or Initial Caps by pressing the **CAPS** and **Initial Cap** buttons in the top of the display. If neither of these are selected, all text is inserted in lower case.

**Note that the first text to be inserted from the Channel Name display when it is opened overwrites all previous text.**

**Note also that text that extends beyond the end of the text box will not be visible!**

In addition to the standard word set, a list of user-defined words can be created and inserted by pressing the **custom** button, located next to the **Initial Cap** button. The button lightens to indicate that the custom set is displayed.

CAPS	Initial Cap	custom	edit	Channel Name								CLEAR	CLOSE	
				Soprano	Euphcnium									0
				Upper										1
				Lower										2
				Back										3
				Contact										4
				electric										5
														6
														7
														8
														9
														L
														R

To add a new word to the custom set, touch the box which you want to use and press **edit**, located next to the **custom** button, to bring up a QWERTY keyboard display. Type the required word and press **OK**. In this keyboard display, the **Next** button saves any text inserted in the current box and moves the keyboard to the next box in the custom list. To cancel the keyboard display, press **CAN** within the display, or press **edit** again. The words in the custom list are inserted into the channel name text box in exactly the same way as words in the standard list. Pressing **custom** again returns the display to the standard word set.

**Tip: As custom names appear in the box in which they are typed, they are not automatically alphabetised. The user may find it helpful to define a system for ordering the custom page.**

**Note also that the standard word set cannot be edited.**

The current name can be cleared by touching the **CLEAR** button towards the top right-hand corner of the **Channel Name** display. The **Channel Name** display can be closed by touching the **CLOSE** box, in the top right-hand corner.

## 1.9 Channel Processing

The signal processing order in each channel type follows the order displayed in the channel strip: Filters - Insert point A - EQ - Compressor/Gate - Insert point B.

Note that there is one insert available to each channel, using Insert position A or B.

### 1.9.1 EQ .....

The EQ section comprises four user-configurable parametric filters and a pair of swept High-pass and Low-pass filters.

The EQ is accessed by touching the on screen display to **Assign** the channel (**the colour changes to yellow**) and then using the controls on the right hand side of the screen.

When a control is adjusted the expanded view seen below appears in the input screen but this view can be seen at any time by touching the EQ response graph on the screen.

**Note - If the expanded view does not appear when a control is adjusted open the Options panel and set the Auto Expand EQ option to Yes**

Touching the normal EQ response graph will show an expanded view in a separate panel.

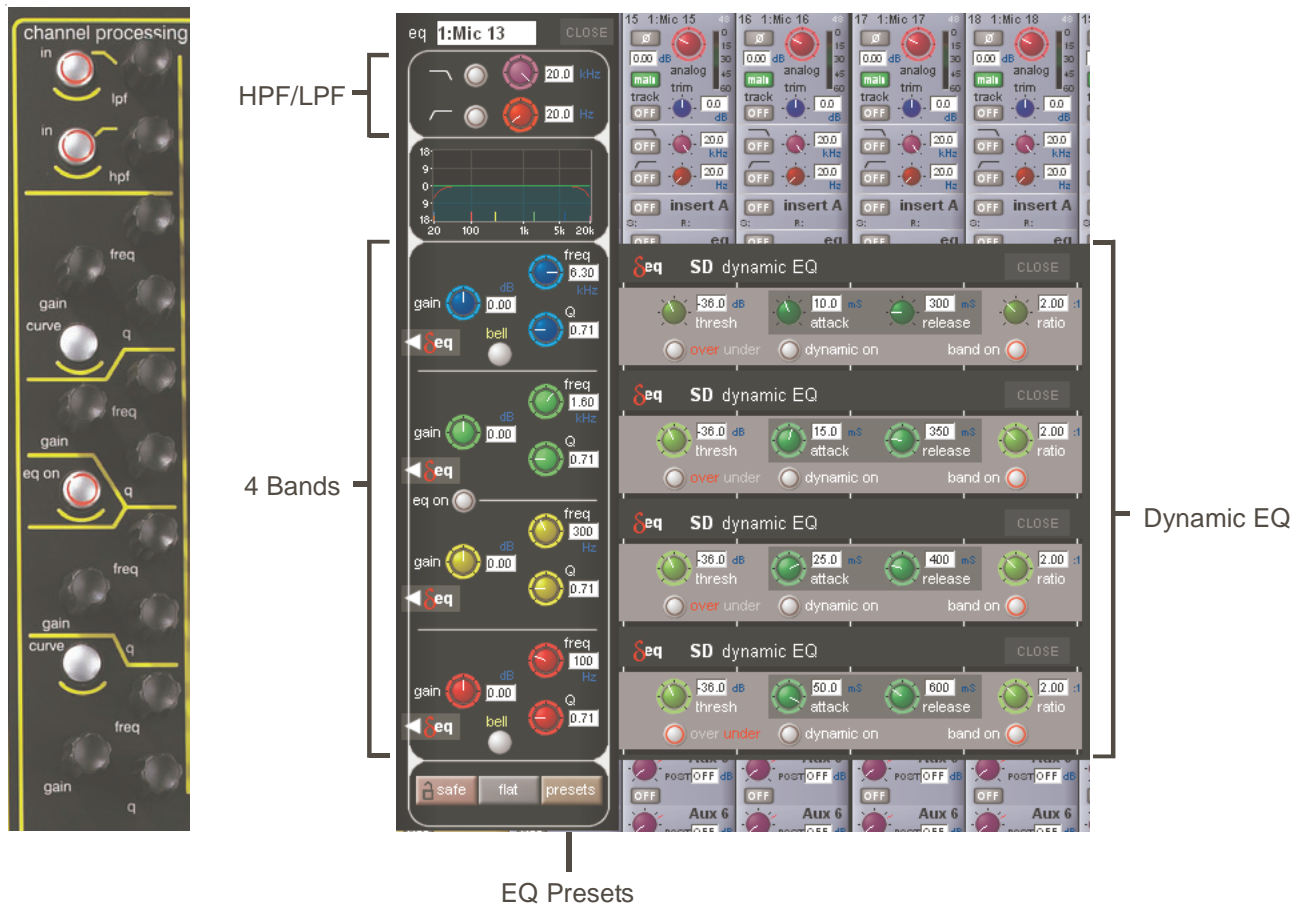

The type of filter used by the top and bottom bands can be changed by successive presses of the **Curve** button for that band.

Up to 4 Channels can have their EQ modules switched into Dynamic EQ mode by touching the red "Delta" symbol on any EQ band. On any channel (Input or Output), open the EQ Module, and expand the dynamic controls. You can then switch on any (or all) or the dynamic controls for that EQ Module.

An warning message will appear on screen if an attempt is made to use Dynamic EQ on more than 4 channels.

**See Section 2.8 - Channel Signal Processing for more information on Dynamic EQ**



# Chapter 1

## 1.9.2 Dynamics

The dynamics are accessed by touching the words **Comp** or **Gate** just below the EQ graph on screen to open the dynamics panel. The worksurface controls beneath the screen control the various parameters. Touching the **Close** button in the top right corner of the panel will close it.

Dedicated **Threshold**, **Gain** controls and **In/Out** switches can be found on the right hand side of the screen. These can control the Assigned channel's dynamics whether the on screen dynamics panel is open or not.

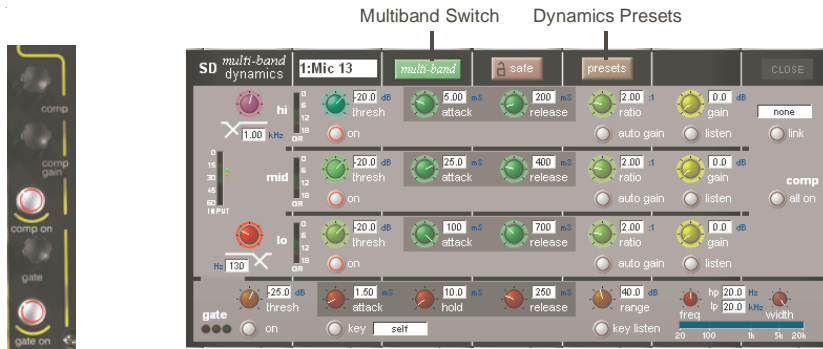

Up to 4 Channels can have their Dynamics (Compressor) modules switched into Multi-band mode. On any channel (Input or Output), open the Dynamics Module, and expand the dynamic controls using the multi-band button. A warning message will appear on screen if an attempt is made to use Multi-band dynamics on more than 4 channels. Each band includes all of the parameters found in the single band compressor. The link function remains available for the whole compressor, and is not assigned to any band. The bands can be switched on individually using the **on** buttons in the left-hand side of each band, or together using the **all on** button to the display's right.

**Note: When any band is switched Off, that Band will not pass audio.**

The crossover frequency between bands is controlled using the purple and red pots to the left of the **hi** and **lo** bands. Each crossover has a range of 20Hz to 20kHz, and the crossover frequencies are displayed below each pot. Each band can be auditioned by pressing the **listen** button below each **gain** pot which solo's that band to the mix (not the solo buss), in effect temporarily switching off the other bands. Pressing **multi-band** again returns the compressor to single-band. The channel strip's compressor threshold and gain controls adjust all three bands' controls, maintaining any relative offsets. The individual controls are mapped to the assignable rotaries below the screen.

**Note:** Beyond the link function, the single and multi-band compressors have completely separate settings: No settings are copied between them, and the settings of each remain unchanged when the other is active. Note also, however, that multi-band and single band dynamics cannot both be active on one channel at the same time.

## 1.9.3 Auxiliaries

The auxiliaries can be accessed by touching the **Aux Quick Select** button, the auxiliary row on screen or using the **Screen Scroll** buttons. Using either of these methods, the highlighted auxiliaries on the input screen will change. The row of rotary controls and switches beneath the screen are used as aux send levels, pans (2nd Function), On/Off and pre/post switches (2nd Function).

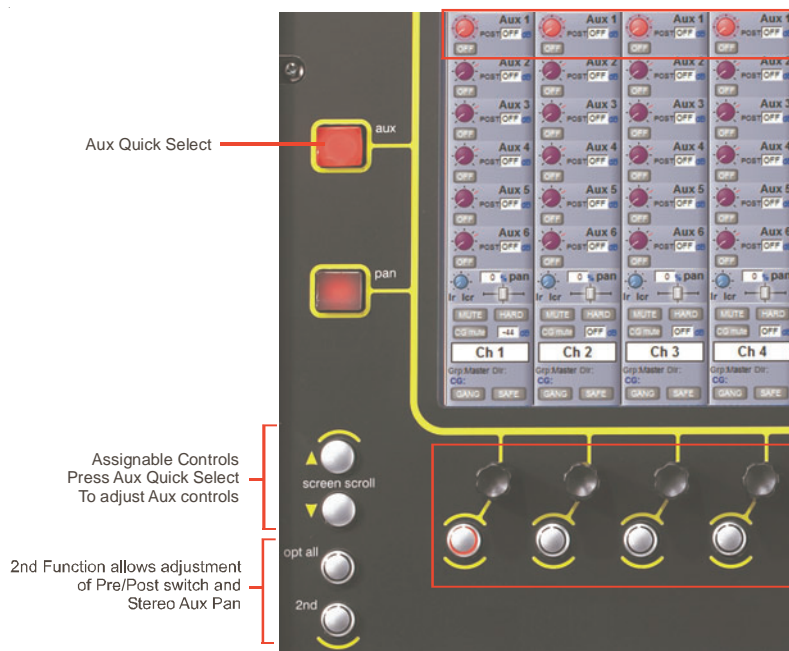

## 1.10 The Matrix

To open the Matrix Inputs panel, touch the Matrix button on the Master Screen Menu. The window that opens allows you to route inputs to the Matrix Output Channels, and set the Matrix crosspoint levels.

To route an input, touch the top of the appropriate Matrix column. This opens a standard SD11 input routing page.

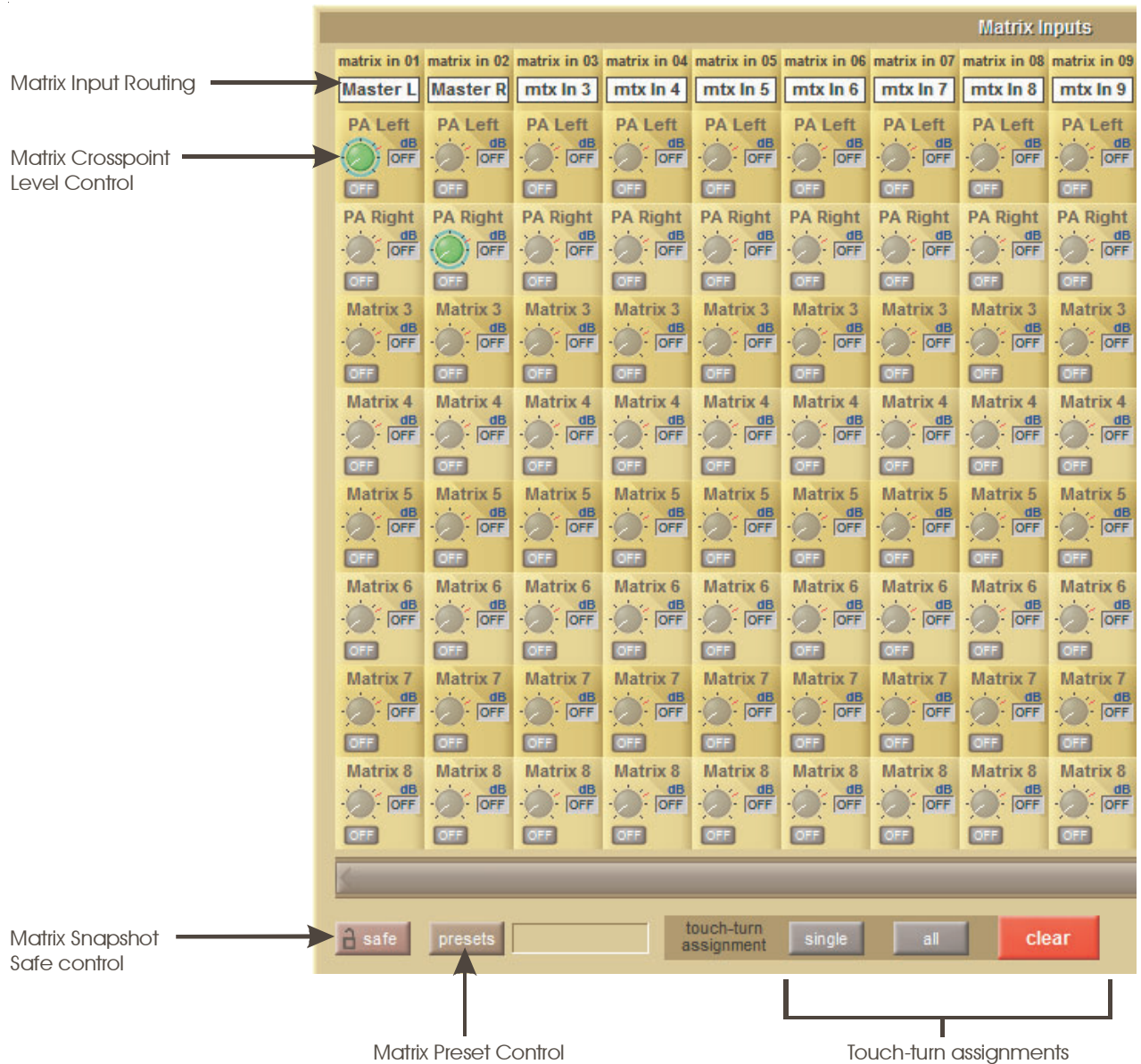

The example above has the Master Stereo Buss routed to the inputs of Matrix 1 and Matrix 2 (Labelled as PA LEFT & PA RIGHT). By adjusting the crosspoint levels, you can change how much of each side of the Master buss is fed to these Matrix Channels.

There are three modes of level adjustment : **multi, single & all.**

**Multi** : Touch one or more level “knob” on screen, then adjust using the Touchturn control.

**Single** : Touch any level “knob” and adjust. Touching another “knob” will deselect the first.

**All** : All “knobs” are adjusted at the same time.

When adjusting more than one crosspoint, their relative levels are maintained.

# Chapter 1

## 1.11 Control Groups

Any number of input channels and output channels can be connected to one or more of the 8 Control Groups. They can then all be operated from a single worksurface channel. Changes to the Control Group fader, mute or solo or controls will affect all channels connected to the group.

There are 2 methods to set up Control Groups:

1) Press the **LCD Function** button on the CG fader bank followed by the **JOIN CG** button;

Press the channel select button for the CG that you want to use;

Press the channel select buttons for each of the channels to be included in the CG;

Deselect the **JOIN CG** button:

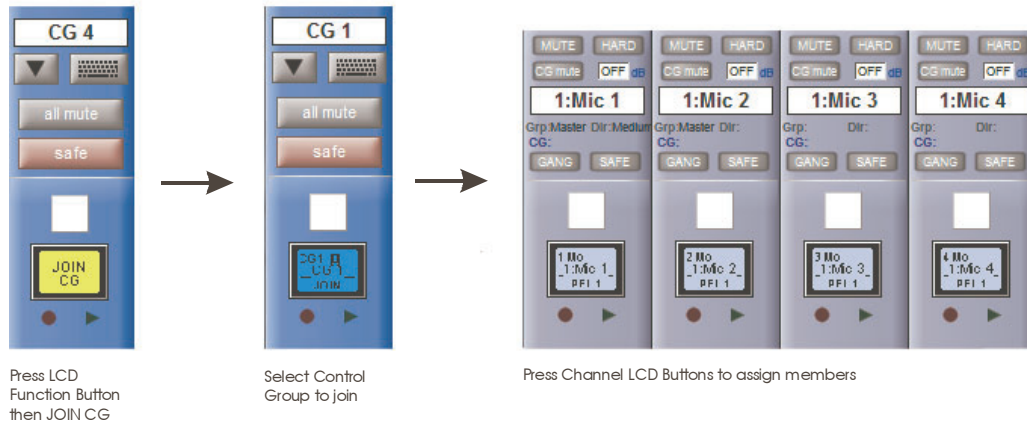

2) Press the on screen **JOIN/LEAVE** button for the required CG channel;

Press the channel select buttons for each of the channels that you want to make members of the CG;

Release the **JOIN/LEAVE** button:

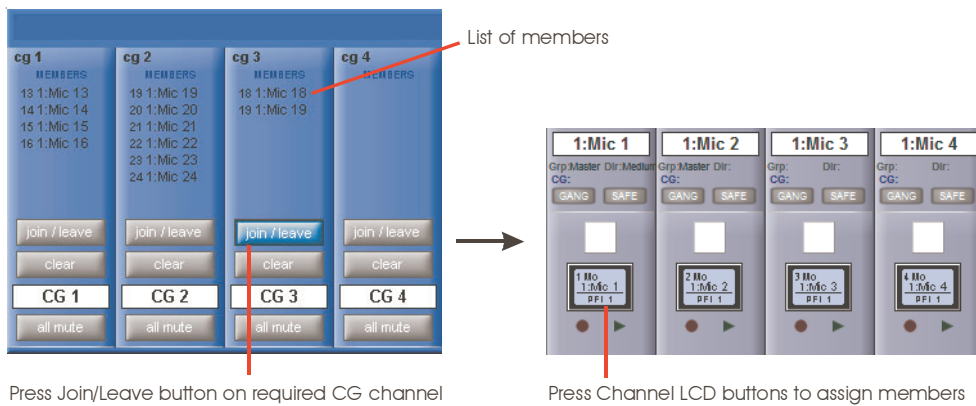

A list of all the connected channels and their names is displayed above each Control Group display.

You can also clear all the channels from a Control Group by pressing **Clear**.

When a channel is a member of a Control Group, its own controls can still be adjusted independently of the other Group members. Adjustments to fader levels are transmitted to the Group members as dB changes, so that a level increase of 2dB on the Control Group fader will increase all the member levels by 2dB, irrespective of the relative levels of the individual channel faders.



## 1.12 Solo Setup

The SD11 Solo panel is accessed from a button at the top of the Master Screen. Some of the controls on this panel are duplicated in the solo panel above the touchscreen.

There are two solo busses and each channel on the consoles can be independently assigned to use Solo1, Solo2 or Solo 1+2. Therefore, if the console was being used for Stage monitors, the first solo buss could feed "In-Ear" monitors, and the second solo buss could feed a wedge.

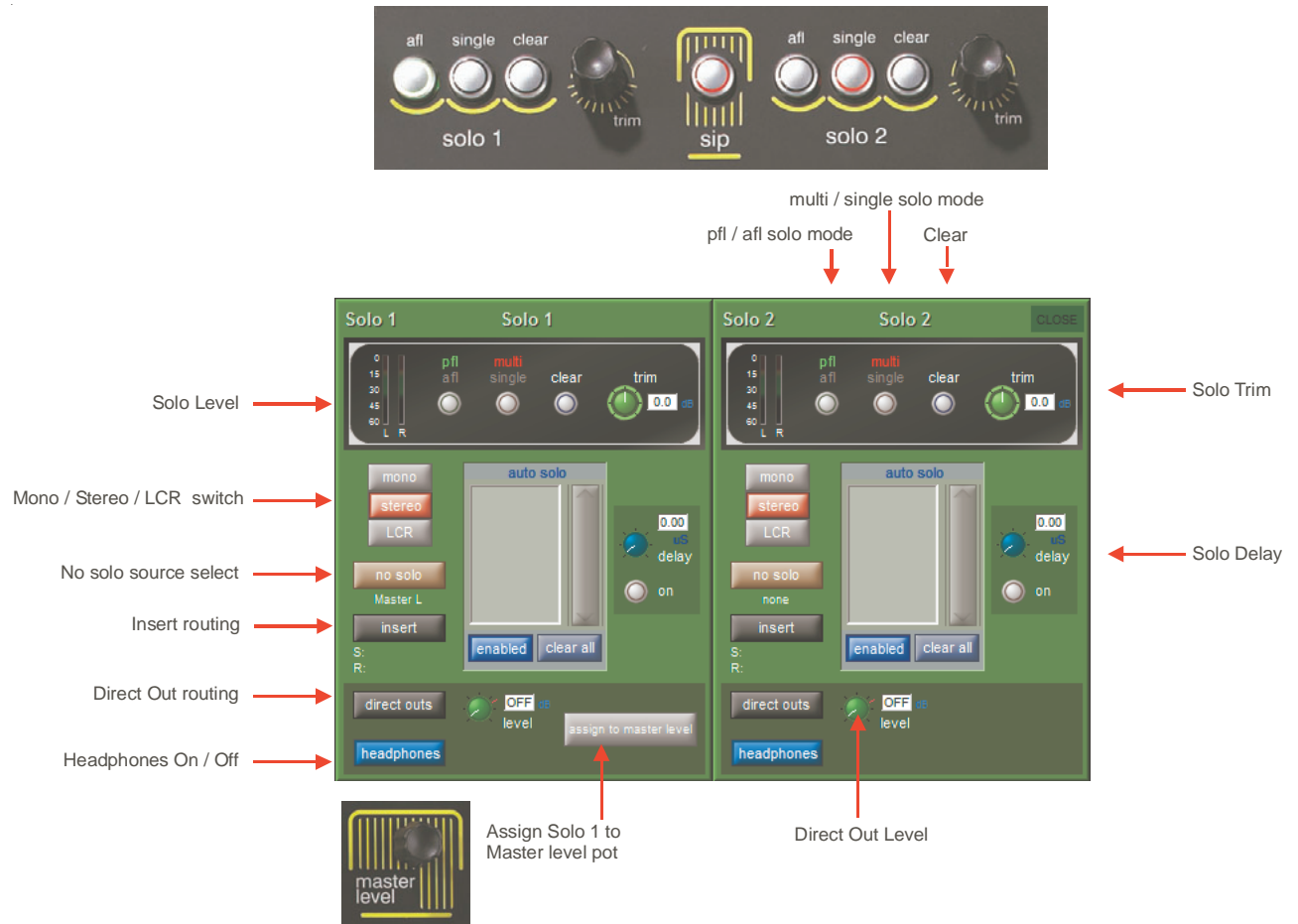

The following functions are available independently for each solo buss :

- Mono / Stereo / LCR Switch
- No Solo source selection (the solo buss source when no channel is soloed. No Solo source does not show on Solo meters.)
- Insert Point with both internal and external routing capability
- Direct Out routing (eg. for feeding a wedge)
- Assignment of worksurface **master level** encoder to Solo 1 buss master
- afl or pfl mode
- single or multi solo mode
- clear solos button
- Delay
- Level Trim

Note that the **afl** / pfl, **single** / multi and **clear** solos buttons are duplicated above the touchscreen, along with a level trim pot.

# **SD11 Operation Manual**

## **Chapter 2:**

### **Channel Types and Functions**

# Chapter 2 - Channel Types

## 2.1 Introduction to Channel Types

This chapter describes all of the functions available within the SD11's channel strips. The first two parts of the chapter will examine the Input/Setup and Output sections of each of the types of channel strip, and the third part will cover the in-channel signal processing, which functions in precisely the same way on each channel type. Those elements which are common to each channel type are dealt with first, and then those elements which are specific to a channel type are dealt with separately.

In order to understand this chapter, you will find it helpful to have read Chapter 1 (Getting Started).

## 2.2 Channel Input Setup - Common Elements

### 2.2.1 Channel Strip Input Area .....

The channel strip input section is located at the top of the channel strip in the Channel Strip panel (shown below for an Input channel). This is where the channel inputs, snapshot safes, and solo bus feeds are configured. Some basic controls are displayed in the channel strip. However, most of the input parameters are contained in the channel **Setup** display, accessed by touching the channel's input or filters areas at the top of the screen. The **Setup** display also contains a number of channel configuration elements.



*Note that channels without an input selected display a simpler input section than that shown here.*

The large pot at the top of the input area of the main channel strip controls the input level, and can be adjusted by pressing the **Quick Select Gain** button and using the controls below the screen. For Input channels which have ADC's assigned to their inputs, this remotely controls the analogue gain of the mic pre-amp in the I/O rack. For all other input types, this is a digital level trim. The gain value is displayed to the right of the level pot.

To the left of the pot there is a phase reverse button which is grey when inactive and red when switched in.

In output channels, the lower half of the channel strip input area contains the input delay controls: The delay is switched on using the on/off button on below the on screen total delay readout. The button turns red to indicate that the delay is active. The small pot to its right determines the course delay amount, and the current course delay value is displayed above the on/off switch. These controls can be adjusted by pressing the **Quick Select Gain** button, scrolling down once and using the controls below the screen. On Output channels, the delay can then be adjusted more finely by pressing the **2nd function** button and using the same control. This value is displayed in microseconds or milliseconds to the right of the delay pot.

Note that, in Input channels, the lower half of the channel strip input area is used for trim and track controls. The delay function is found within the **Setup** display, not in the channel strip.

### 2.2.2 Channel Names .....

The black and white text box in the **Setup** display is used for naming the channel. Channel names are displayed in the scribble strip at the bottom of the screen. By default, the channel is given the same name as the selected input signal.

Note that if no input signal is selected, the scribble strip simply displays the channel number, prefixed by **ch** for Input channels, and prefixed by **Aux**, **Grp** or **Matrix** in the case of output channels.

The following notes are specific to naming channels:

The **Next** button moves the entire **Setup** display to the new channel.

At the very top of the channel, the channel number and input signal name are displayed for Input channels, and the channel type and number are displayed for output channels. These labels remain unchanged, regardless of any channel naming.

For Input channels, note that if the channel input signal is changed once a channel has been manually named, the channel name will no longer follow the input signal name. To reactivate the automatic channel naming function, clear the name and re-select the channel input.

Note also that the channel **Output** display also provides access to this channel naming facility.

**2.2.3 Channel Safes .....**

The **Channel Safes** area of the **Setup** display defines which parts of the channel will not be affected when snapshots are recalled to this channel.

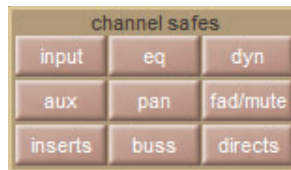

**Note that the above diagram displays the Input channel safes. Output channels display a smaller list of available channel safes.**

Select whichever parts of the channel you want to protect in this way by touching the appropriate button. To cancel a safe, press the relevant button again. The buttons turn red to indicate that they are safed. The presence of safes within the channel is also indicated by the label of the appropriate channel part turning red and the background colour of that channel's name also turning red.

The EQ and dynamics settings can also be safed and unsafed from within the **eq** and **dynamics** displays. The whole channel can also be safed and unsafed by pressing the **SAFE** button at the bottom of on-screen channel (Offline software). It is grey to indicate that some elements of the channel are not safed, and red to indicate that the entire channel is safed.

**Tip: When some elements of the channel are safed, a press on the SAFE button can be used to quickly clear all channel safes.**

**Note: Channel safes refer specifically to snapshot recalls and do not protect channel settings when using the copy from, copy to and presets functions described below.**

**2.2.4 Channel Settings .....**

The **Channel Settings** area of the **Setup** display allow channel settings to be copied between channels. The left and right arrow buttons are used to move the **Setup** display to adjacent channels.



The **copy from** button allows settings to be copied from other channels to this channel and those to its right: Pressing **copy from** opens up a **Copy Channels** display:

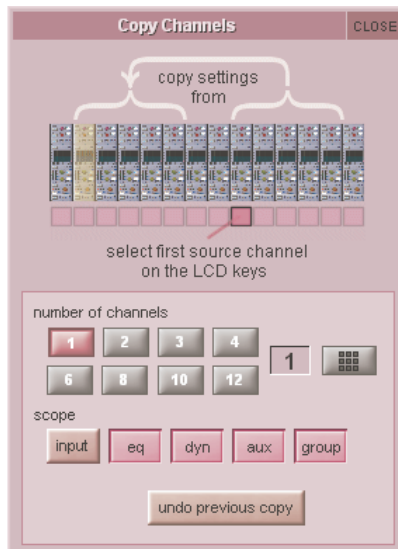

## Chapter 2 - Channel Types

The extent of the channel settings to be copied is selected using the **scope** buttons towards the bottom of the display. Each button lightens to indicate that it is included in the copy function. The number of source channels to be copied is defined either by selecting the appropriate grey numbered button, or by selecting the keypad button to the right of the numbered buttons, typing the required number of source channels into the numeric keypad which appears, and pressing **OK**. Press the Channel Select button (shown below) on the left-most source channel in order to action the channel copy. If more than one source channel has been selected, the settings of appropriate number of channels to the right of the source channel will copy to the channels to the right of the destination channel (The current Assigned channel).

For example, to copy the EQ settings on channels 1-8 to channels 9-16 respectively:

- Make channel 9 the Assigned channel and touch **copy from**
- In the scope area of the **Copy Channels** display, select only the **eq** button
- Set the **number of channels** to be **8**.
- Press the Channel Select button on channel 1.

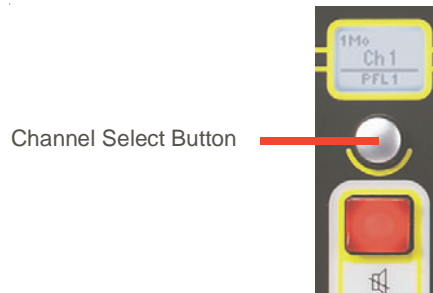

The **copy to** button allows settings to be copied from this channel to other channels: Pressing **copy to** opens up a **Copy Channels** display:

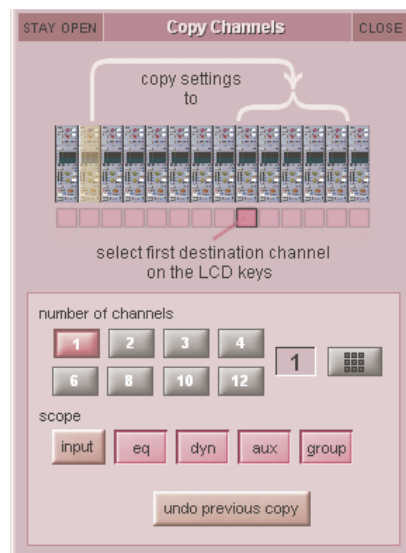

**Note that this is a different Copy Channels display from that opened by the copy from button.**

The extent of the channel settings to be copied is selected using the **scope** buttons towards the bottom of the display. Each button lightens to indicate that it is included in the copy function. The number of destination channels to which this channel's settings will be copied is defined either by selecting the appropriate grey numbered button, or by selecting the button to the right of the numbered buttons, typing the required number of source channels into the numeric keypad which appears, and pressing **OK**. Press the Channel Select button (shown above) on the left-most destination channel in order to action the channel copy. If more than one destination channel has been selected, the settings of the source channel will copy to the appropriate number of channels to the right of the selected destination channel.

For example, to copy the EQ settings on channel 1 to channels 9-16:

- Make channel 1 the Assigned channel and touch **copy to**
- In the scope area of the **Copy Channels** display, select only the **eq** button
- Set the **number of channels** to be **8**.
- Press the Channel Select button on channel 9.

If a **copy from** or **copy to** function is actioned by mistake, it can be undone by pressing the **undo previous copy** button in the current **Copy Channels** display.

**Tip:** Use copy to for copying one channel's settings to a number of other channels; Use copy from to copy the settings of a group of channels to another group of channels.

**Tip:** If you wish to make several different copies press the **STAY OPEN** button on the Copy From or Copy To panels and the panel will remain open until it is manually closed with the **CLOSE** button

Pressing the **presets** button opens the **Presets** display. The basic functions of a Preset display are described in the Getting Started section.



**Note that presets are specific to a channel type: The Presets display will only list those presets which apply to the current channel type.**

To reset the channel to the default settings, press **default**.

### 2.2.5 Channel Solos .....

The SD11 has two solo busses, and each channel can be assigned to **solo 1**, **solo 2** or both **solo 1** and **2**. If the console was being used for Stage monitors, this would allow, for example, the first solo buss to feed In-Ear monitors and the second solo buss to feed a wedge.

**Note: The solo busses are configured in the master solo displays, accessed by pressing the Solos button at the top of the Master Screen.**



The channel's solo routing is assigned in the section at the bottom section of the channel Setup display. Pressing the green **solo 1** and **solo 2** buttons enables the channel to be routed to solo busses 1 and 2 respectively. The buttons are green to indicate that the solo bus is available, and grey to indicate that it isn't.

**Note that each channel must be enabled for at least one solo buss.**

When the blue **auto solo** buttons are active (indicated by white, rather than grey, text), that channel is automatically routed to that solo bus whenever another channel is soloed to that buss.

**Note that a list of channels with auto solo enabled is displayed in the auto solo section of the master solo display. The auto solo function has to be activated by pressing the blue enabled button below the auto solo list in the master solo display.**

**Tip: If you are using effects returns, selecting auto solo can allow soloed tracks to be auditioned with their effects returns.**

# Chapter 2 - Channel Types

## 2.3 Channel Output and Inserts - Common Elements

### 2.3.1 Channel Strip Output Area .....

The channel strip output area makes up the lower half of the Channel Strip panel. This is where the channel output routes are configured (including Aux outputs in the case of Input channels).

Each channel also has an insert point which can be positioned before the EQ and dynamics (**insert A**) or after them (**insert B**). The insert follows the format (mono, stereo or LCR) of its channel. The channel strip insert areas are located above the **eq** section (**insert A**) and below the **gate** section (**insert B**), and their signals are sent and returned to that position within the signal path: **insert A** is pre-signal processing (but post filters), and **insert B** is post signal-processing.

*Note that once you have engaged Insert A or B, the other insert point becomes unavailable.*

Some basic output and insert functions are found in the channel strip. However, most of the output and insert parameters are contained in the channel **Output** display, accessed by touching the channel's output or insert areas.

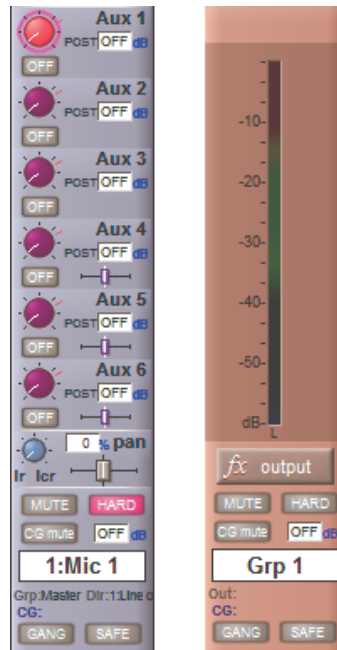

For all output channel types, there is a channel meter displayed in the channel strip. For Input channels, this part of the channel strip contains the aux outputs, as shown above.

Below the meters section of the output channels, there is an **fx output** button. This button brings up either the controller display for the effects preset that has been assigned, or the **fx Presets** display if no preset has been assigned.

*Note that below the aux section of an Input channel, there is a pan control in place of the fx output button. When an effects preset has been assigned to that channel's Direct Out, touching this pan control brings up the FX preset controller display.*

Towards the bottom of the channel strip there is a scribble strip of black and white text boxes displaying the channel names.

*Note that the channel naming facility is found in both the channel Setup and Outputs displays.*

Below the channel name, there is indication of the lowest group (**Grp:**) output (along with indication of the lowest direct output (**Dir:**) in the case of Input channels), and indication of any control group (**CG:**) to which the channel belongs.

The on-screen channel has **MUTE** and **HARD** indicators located above the scribble strip. Pressing the worksurface **MUTE** button silences all outputs from the channel apart from any which have been assigned pre-mute (this option is available for auxes and direct outs) Pressing the worksurface **2nd Function** button to activate the **HARD** mute silences all outputs from the channel, including those which are assigned pre-mute.

Immediately below the **HARD** button, there is a numeric display of the channel's main fader value in dB.

Below the **MUTE** button there is a **CG MUTE Indicator** which shows when the channel is muted as the result of its membership of a muted **Control Group**.

In the bottom left-hand corner of the channel strip, there is a **GANG** display. To the right of the **GANG** button there is a **SAFE** button. This indicates the Safe status of the channel.

**2.3.2 Channel Strip Insert Areas .....**

Both channel strip insert areas include a button for switching that insert on and off. The button is grey when the send is off, and red when it is on.

*Note - If the Insert button is off the Insert Send will still be active if routed to an output.*

Below the on/off button, there is a display of the current insert routing. The send route is displayed on the left, prefixed by **S:**, and the return route is displayed on the right, prefixed by **R:**. If no routing has been selected, these areas are blank apart from these prefixes. If the channel is stereo or LCR, only the left side of the insert routing is displayed.

**2.3.3 Console Output and Insert Routing .....**

The **Output** displays for all four channel types allow direct routing either to the external IO racks, or to one of a variety of internal locations, for both the channel's main output (or direct output in the case of Input channels), and its insert send and return. Towards the bottom of the **Outputs** display, there are three buttons marked **output** (**direct** in Input channels), **insert A** and **insert B**. Selecting one of these buttons assigns that send (or send and return) to the signal routing area above it: When either insert is assigned, the **ins A send** or **ins B send** routing button appears in the left-hand column, and the **ins A return** or **ins B return** routing button in the right-hand column; When the output (direct output in Input channels) is assigned, the **outputs (direct outs** in Input channels) routing button appears in the left-hand column and the right-hand column is left blank. Pressing any of these routing buttons opens a routing display.

An extra button labelled **send+return** is included above the **ports** list in the **Insert Send Route** display. When this button is activated, the send and return routing is linked for all signals within the **INTERNAL** port: If the **Graphic 1** input is assigned to the insert send, the **Graphic 1** output is automatically assigned to that insert return. Similarly, if it is the return which is manually assigned, the send automatically copies that send assignment. The **send+return** button is grey when inactive and brown when active.

The **mono > mono** and **mono > stereo** buttons are used when routing a mono channel to internal fx units and Waves plug-ins (where available). When **mono > mono** is selected, the channel signal is routed to left side of an fx unit, or to a mono Waves rack input. When **mono > stereo** is selected, the channel is routed to both sides of the fx unit or Waves rack.

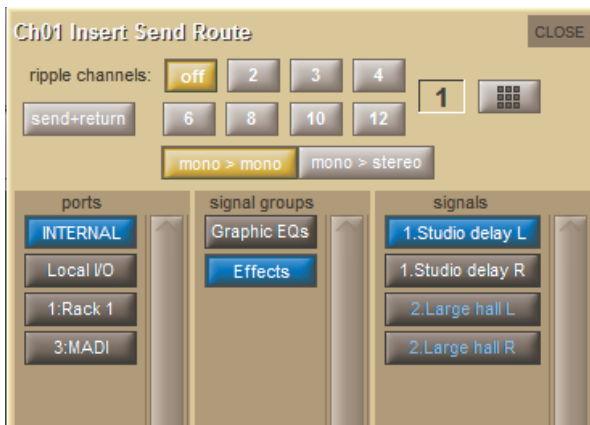



## Chapter 2 - Channel Types

### 2.3.4 FX Presets .....

Each channel output or insert send can be sent to an internal FX Unit. Pressing the **fx presets** button at the bottom of the **Outputs** display brings up the **fx Presets** display. The fx preset is applied to whichever channel output is active in the **Outputs** display when the **fx presets** button is pressed: the main channel output (or direct output), insert send A or insert send B:

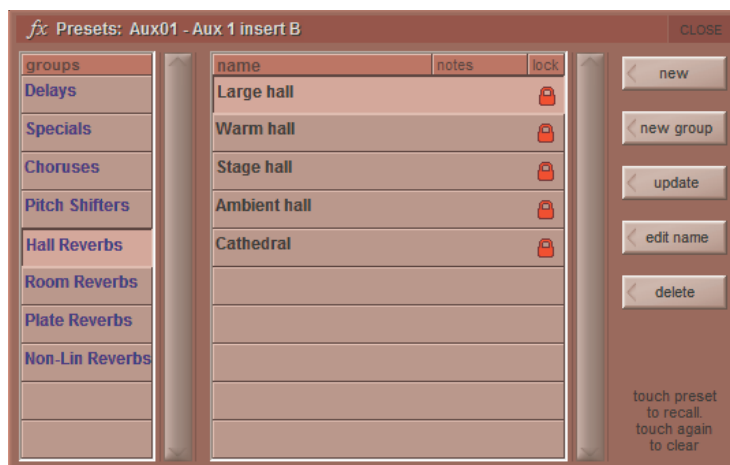

The basic functions of Preset displays are described in the Getting Started Chapter. Functions specific to fx presets are described below.

A number of factory presets are provided, and these provide the basis for any user-adjusted presets. Factory presets are indicated by the presence of a red padlock in the **lock** column on the right, and are described below.

Once an effects preset has been adjusted, it can be saved, either as a new preset or as an updated version of the preset that has already been created, to prevent the changes from being lost:

To lock the preset, activate the **edit name** button and touch the preset's **lock** column. A grey padlock appears, indicating that the preset is now locked. Touching the lock again with **edit name** active unlocks the preset. All master presets are locked and cannot be unlocked. Master presets can be distinguished from user presets by the red colour of their padlocks.

**Note - that factory preset group names can be edited, even though the presets themselves cannot.**

Once an effects preset has been assigned, the **fx output** button in the channel strip recalls the preset's controller display. In the case of Input channels, once an effects preset has been assigned, the preset's display can be recalled by touching the pan area of the channel strip. The **fx Presets** display can then be recalled by pressing the **fx presets** button within the controller display.

Each FX unit can be safed by pressing the **safe** button at the top of its display. The channel's name and output are also shown at the top of the display, and each effect displays its input and output levels in meters in the left-hand side of the controller.

**Note - any selection of up to four stereo effects can be assigned on an SD11.**

**Note - If Presets are greyed out in the presets list this means that the maximum number of Presets has already been used**

When an fx unit is open in a channel screen, its controls are assigned to the assignable encoders below the screen. Each value is displayed to the right of its pot.

To delete a module, simply deselect it within the presets display.

## The Master FX Display

Selecting the **fx** menu button in the master screen opens the master **fx** display, which shows all of the currently assigned fx units in a single rack. Touching any control in this display allows adjustments to be made using the worksurface **Touch Turn** controls.



It is also possible to create and delete modules from this display:

To create a new module, click on the **New** button in the top left-hand corner of the fx window to bring up the **fx Presets** display, then select the appropriate preset in the usual way. Routing to fx modules is then performed in the channel **Outputs** display.

To delete a module, click on the **fx presets** button on the module, and deselect the preset in the **fx Presets** display which appears.

## 2.4 Input Channel Specific Functions

### 2.4.1 Trim and Track .....

On Input channels with an external input, there is a trim section at the bottom of the channel strip's input area, consisting of a smaller pot marked **trim** and a **track** on/off button. The **trim** pot trims the level of the digital input signal, and the level adjustment is displayed to the right of the pot in dB. If **track** is switched on, the trim level automatically compensates for any adjustments made to the analogue input level: If the analogue input level is increased, the trim level will decrease in order to keep the signal level coming through the channel at the same level. This function is particularly useful when the analogue level is being controlled from another console, such as when this console is running monitor mixes and another console is running Front of House. Control of the **trim** pot and **track** on/off button can be assigned to the encoder and button above the channel using the **assign** scrollers to the right of the encoders.

### 2.4.2 Input Routing .....

The two buttons at the top of the channel **Setup** display to define the format of the channel: **mono** or **stereo**.

As the channel format affects a number of functions within the **Setup** display, it is advisable to select the format before any further configuration takes place. The current format of the channel is indicated in the channel strip by the number of meters displayed: One meter for mono channels and two for stereo.

For mono channels, each input channel has two inputs: a **main** input and an **alt** (ernative) input. These are selected using the **main** button in the channel strip. The button is green when the **main** input is selected and red when the **alt** input is selected. The input can also be selected using the **main** and **alt** buttons towards the top of the **Setup** display. These buttons light to indicate which one is currently selected. For stereo channels, the alternative input is becomes the right side of the stereo input, and therefore no **main** and **alt** input selection buttons are shown.

**Note: a -20dB pad button is provided for analogue inputs from the SD11 Local I/O and D-Racks but this will not be available if an input is taken from any other DiGiCo rack**



The inputs available on an Input channel include feeds from the external IO racks, the local inputs on the back of the console and a variety of internal signals. Pressing either the **main input** or **alt input** routing button in the **Setup** display opens the **Input Route** display. The signal feeding each input can then be selected as described in the Getting Started section of this manual.

### 2.4.3 Input Configuration .....

If a channel is stereo, **balance** and **width** controls appear below the **mono** and **stereo** buttons: The left-hand blue pot controls the balance and can be reset to centre by pressing the **centre** button below it. The right-hand blue pot effects the width of the stereo signal, with a range from mono to wide. The width can be reset to stereo by pressing the **stereo** button beneath the **width** pot. The value of the balance and width is displayed to the right of each pot as a percentage divergence.



Stereo channels also have an **m-s** button, located above the input routing button, which switches in a decode function for replaying M-S signals as a normal stereo pair. There are three further buttons in this panel: **L<>R** swaps the channel's left and right outputs, **L>L+R** sends the left signal to both left and right busses, and **R>L+R** sends the right signal to both left and right busses.

Input channel delay controls are found below the input routing area of the **Setup** display. The delay is switched on using the **on** button, which is ringed in red to indicate that it is on. The left-hand blue pot controls the coarse delay amount in milliseconds. To enter a precise amount, touch on the square keypad symbol, enter a value in the numeric keypad which appears and press **OK**. The right-hand blue pot enables fine adjustments to be made to this delay amount, measured in samples. Both controls can be assigned to the encoders below the screen by touching them on the screen.

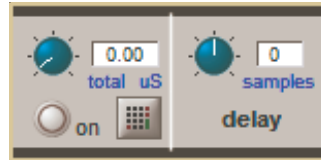

### 2.4.4 Output Routing .....

Signals can be fed from Input channels to four different places: aux busses, group busses, insert sends and direct outputs. Insert routing and basic direct output routing are described in full in the Getting Started chapter.

The top half of the output section of the Input channel strip contains the aux buss controls, described in the Getting Started section of this manual.

Below the auxes, there is a pan control. On mono channels, the pan control affects the relative levels of the channel's left and right outputs to any stereo routing destinations. The pan control can be assigned to the row of assignable encoders below the screen by pressing the **Quick Select Pan** button.

There is also an **LR/LCR Blend** control that is accessed by pressing the **Quick Select Pan** button and then using the worksurface **2nd Function** button. This control allows adjustment of the amount of signal that is sent to an LCR Master buss. In the extreme left LR position, no signal will go to the centre leg of the LCR buss:

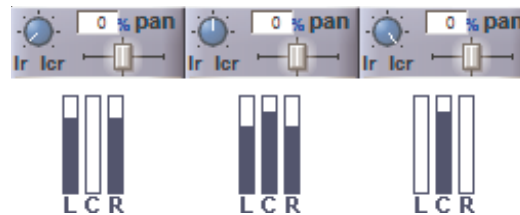

The numeric box above the pan control displays the pan value as a percentage of divergence from centre, with left panning being indicated by a negative value.

### 2.4.5 Aux Busses and Assignable Controls .....

Within an Input channel strip, each aux send has a level trim and on/off switch. The switch is grey to indicate that the send is off, and red to indicate that it is on. The trim level is displayed in dB on the right of the channel strip, underneath the aux number.

There are three places within the channel from which the aux sends can be fed, as indicated by the source display immediately to the right of the level trim:

<b>PRE</b>	Pre-fader
<b>POST</b>	Post-fader
<b>Pre-M</b>	Pre-mute (and pre-fader)

The source position can be changed by pressing the **Quick Select Aux** button, then the worksurface **2nd function** button and using the switches below the screen. The source for each aux can also be adjusted globally via the aux channel's **Setup** display.

On stereo aux sends, there is a pan control to the right of the on/off switch. This can be adjusted by pressing the **Quick Select Aux** button, then the worksurface **2nd function** button and using the rotary controls below the screen. The pan controls for each aux can be globally linked to the channel fader via the aux channel's **Setup** display.

# Chapter 2 - Channel Types

*Note that further worksurface assignments of auxes is available via the Surface and Solo tabs of the Options menu. See the Master Screen Chapter.*

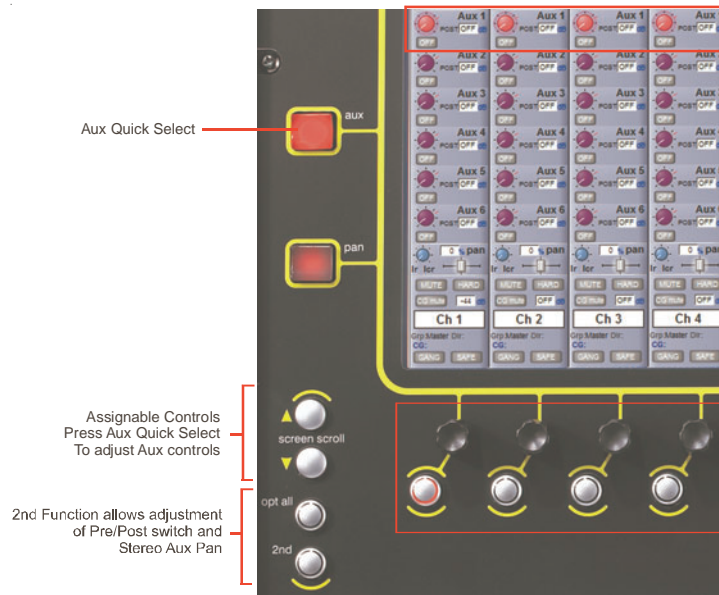

## 2.4.6 Group Outputs .....

Group outputs are routed from within the **groups** section of the channel **Outputs** display. Touching the **mono** button to the left of the display produces a list of available mono groups in the right of the display, and touching the **stereo** button produces a list of stereo groups. These buttons light to indicate that it is their group outputs list which is currently displayed. Touching any of the groups within each list routes the channel to that group. Each channel can be routed to as many mono and stereo groups as have been created.

If your session has been configured with an LCR Master Buss, there will also be an LCR routing option.



Any mono groups being fed by a stereo channel will receive a L+R summed signal of the channel output.

The lowest selected group output is displayed in the channel strip, below the left side of the channel name, and the currently selected direct output is displayed below the right side of the channel name.

When a new session is created, if no LCR buss is created, the lowest numbered stereo group is always designated the **Master**. Therefore, all input channels are routed to it by default, and the master faders are assigned to it.

## 2.4.7 Direct Outputs .....

Basic routing is described in the Getting Started section. Once the direct output has been routed, it is switched on by pressing the grey **on** button next to the output level meter in the grey area below the **direct outs** routing button. The direct out is taken post-fader by default, but can be switched to pre-fader or pre mute by pressing the button to the right of the **on** button. The current selection is displayed to the right of the button. The -10dB pad button is not available on SD11 Loal I/O and D-Rack outputs.



## 2.5 Group Channels Specific Functions

The Group channel input signals are defined within the Input channels' **Output** displays. The top section of the Group channel **Setup** display lists all of the currently selected **inputs** to that group. There is a scroll bar to the list's right if needed. Below the list there are two buttons: **clear all** removes all of the input routes to that group. Pressing this button produces a confirmation box in which the clear all can be confirmed or cancelled. **connect all** routes all Input channels to the group.

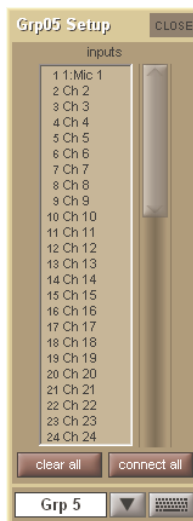

## 2.6 Aux Channels Specific Functions

As the Aux channel input signals are defined within the Input channels, there is no input selection available within the Aux channel **Setup** display. There are, however, a number of configuration options in the top half of the display:

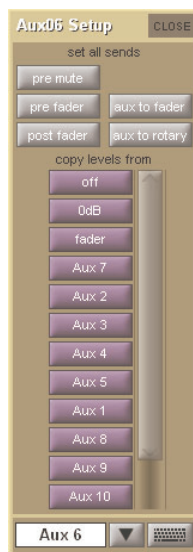

The grey **set all sends** buttons at the top of the **Setup** display affect the sends to that aux bus from all of the Input channels. The three buttons on the left, **pre mute**, **pre fader** and **post fader**, set the point in the channel from which the aux send is taken. The current send point is displayed next to the aux send level in the Input channels.

**Note: send points can also be individually selected within the Input channel using the 2nd function button.**

Pressing the **link pans** button, located to the right of the **pre mute** button, links that aux send pan to the main channel pan in the Input channels. This button lights red to indicate that it is active. Further indication is provided by the aux pan slider in the Input channel strip being lit pink.

Pressing **aux to fader** assigns control of all input channel's auxiliary sends to the channel faders. Pressing **aux to rotary** assigns control of all input channel's auxiliary sends to the top available encoder row beneath the Channel Strip panel.

The purple **copy levels from** buttons also affect the sends to that aux bus from all of the Input channels. The buttons list can be scrolled using the scroll bar on the right. These buttons are used for universally setting the aux send levels: **Off** sets the level to off and **0dB** to 0db. **fader** sets each Input channel's aux send level to match the level of its channel fader. The remaining **copy levels from** buttons copy a different set of Input channel aux send levels to that aux send.

**Note that when a copy levels from button has been pressed, send levels can still be individually readjusted within the Input channel.**

# Chapter 2 - Channel Types

## 2.7 Matrix Channels Specific Functions

The Matrix channel input signals are defined within the Master Screen's **Matrix** display, not within the Matrix channel. See the Master Section chapter for more details.

## 2.8 Channel Signal Processing

Each channel type contains the same signal processing functions. These include high-pass and low-pass filters, a four-band EQ and a compressor/gate. Pressing on each of these areas of the channel strip will open the relevant signal-processing display. The signal processing order in each channel type follows the order displayed in the channel strip: Filters - Insert point A - EQ - Compressor/Gate - Insert point B.

### 2.8.1 Channel Filters

The filters section of the channel-strip is located below the input section. It consists of two frequency pots, each with its own on/off button and a display of the filter's cutoff frequency in Hertz. The on/off buttons are grey to indicate that the frequency band is off, and red to indicate that it is on. The low-pass filter is at the top and the high-pass filter is at the bottom, and both have a roll-off of 24dB per octave. The filters directly follow the input section in the signal chain.

The filters area is replicated at the top of the EQ/filters display, accessed by touching the EQ area of the channel strip. The filter can be configured using the dedicated filter encoders and buttons at the top of the channel worksurface controls:

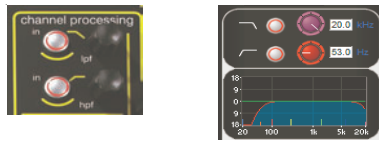

A graphic representation of the filters is included in the EQ graph located below **Insert A** in the channel strip, described below. The red line in the graph represents the current filter settings.

### 2.8.2 Channel EQ

The SD11's channel EQ has four bands. The four EQ bands are colour coded: Blue for HF, green for HMF, yellow for LMF and red for LF. The in-channel display is located below **Insert A** and consists of a graphic representation of the current EQ and an on/off button. The button is grey to indicate that the EQ is off, and red to indicate that it is on. The green line in the graph represents the frequency response of the EQ, and the red line represents the response of the filters. The central frequency of each band is displayed by small lines in the band colours, along the bottom of the graph.

Touching the EQ area of the channel strip brings up the EQ/filters display. The EQ section of the display is below the filters section, and has another graphic representation of the current EQ at the top. Touching this EQ graph will open an expanded view of the graph. The EQ can be configured using the dedicated encoders and buttons on the worksurface which follow the same layout as the display:

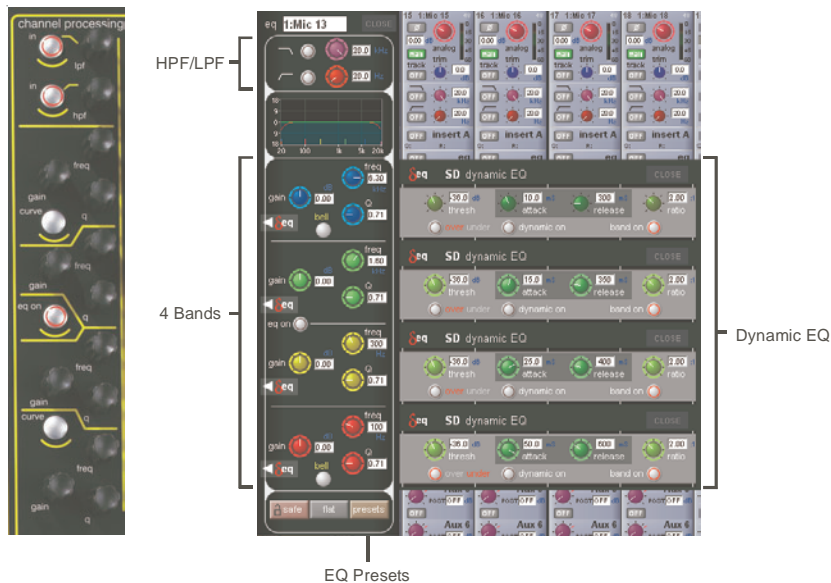

In both the EQ/filters display and on the worksurface, each band has a  $\pm 18$ dB **gain** controller on the left, a **frequency** controller (ranging from 20Hz to 20kHz) top right and a **Q** control bottom right. Each pot has its value displayed to its right. The top and bottom EQ bands have **Curve** buttons that allow the filter type to be switched.

Towards the bottom of the EQ/filters display are three grey buttons marked **safe**, **flat** and **preset**. Touching **safe** adds the EQ to that channel's list of channel safes. Touching **flat** resets the EQ gain controls to 0dB. Touching **preset** brings up the **Presets** display which can be used to save and recall presets.



### Dynamic EQ Details

In a dynamic EQ module, the EQ adjustment is applied dynamically, based on the level of the incoming frequency relative to a predetermined threshold. Dynamic EQ is accessed by touching the red "Delta" symbol on any EQ band. You can then switch on any (or all) or the dynamic controls for that EQ Module.

Up to 4 Channels can have their EQ modules switched into Dynamic EQ mode, and a warning message will appear on screen if an attempt is made to use Dynamic EQ on more than 4 channels.

DiGiCo dynamic EQ can operate in two modes.. "over" or "under."

#### Over Mode

To place the dynamic module into Over mode, ensure that the Over indication below the threshold control is not illuminated.



When the signal entering the module passes the threshold, the EQ adjustment (as determined by the frequency and Q controls) starts to be applied, up to a maximum adjustment, determined by the EQ band gain control. The manner in which the EQ adjustment is applied once the threshold has been reached is determined by the attack, release and ratio controls.

<b>Gain :</b>	Sets the maximum EQ adjustment that could be applied
<b>Frequency / Q / Curve :</b>	Adjusts the EQ characteristics
<b>Threshold :</b>	Sets the threshold at which the EQ starts to be applied
<b>Attack :</b>	controls how quickly the dynamic module responds to level passing the threshold
<b>Release :</b>	adjusts how quickly the module responds to a fall in level
<b>Ratio :</b>	controls how quickly the maximum adjustment is reached once the threshold level is passed.

Over Mode is generally used with a reduction in gain at a specific frequency, such that when the threshold is reached, a gradual reduction of level at that frequency is applied. This could be used to control a change in tonal characteristics as a singer pushes their voice to sing louder.

#### Under Mode

To place the dynamic module into Under mode, ensure that the Over indication below the threshold control is illuminated.



In under mode, the maximum EQ adjustment (as determined by the frequency, Q and band gain controls) is applied when the signal entering the module is below the threshold. As the signal level approaches the threshold, the EQ adjustment is reduced to the point where there is no EQ being applied at the threshold. The manner in which the EQ adjustment is reduced as the signal level approaches the threshold is determined by the attack, release and ratio controls.



## Chapter 2 - Channel Types

### 2.8.3 Channel Dynamics .....

The SD11's channel dynamics includes a fully configurable compressor and a gate with high- and low-pass filtering. The in-channel display is located below the **eq** display.

The compressor can be switched on by pressing the on/off switch to the left of the **comp** label, and the gate can be switched on by pressing the on/off switch to the left of the **gate** label. These buttons are grey when off and red when on.

The channel strip compressor display then includes a **threshold** and gain pot, each with their current value displayed to their right in dB, an input (**In**) meter and a gain reduction (**GR**) meter. The gate display includes a **threshold** pot with its current value displayed to its left in dB, and three status indication lights. The input meter in the **comp** area has two small arrows to its right: The green arrow displays the current compressor threshold, and the orange arrow the gate threshold.

Pressing anywhere in the **comp** or **gate** areas brings up the **dynamics** display. When the expanded display is open the compressor and gate controls are assigned to the encoders below the touch screen.

The compressor and gate can each be switched on using the **on** buttons below their **threshold** buttons. The compressor also has an auto gain function which is switched on by pressing the **auto gain** button below the **ratio** pot. This function automatically adjusts the **gain** makeup to when changes are made to the **threshold**, thus keeping the compressor output steady.

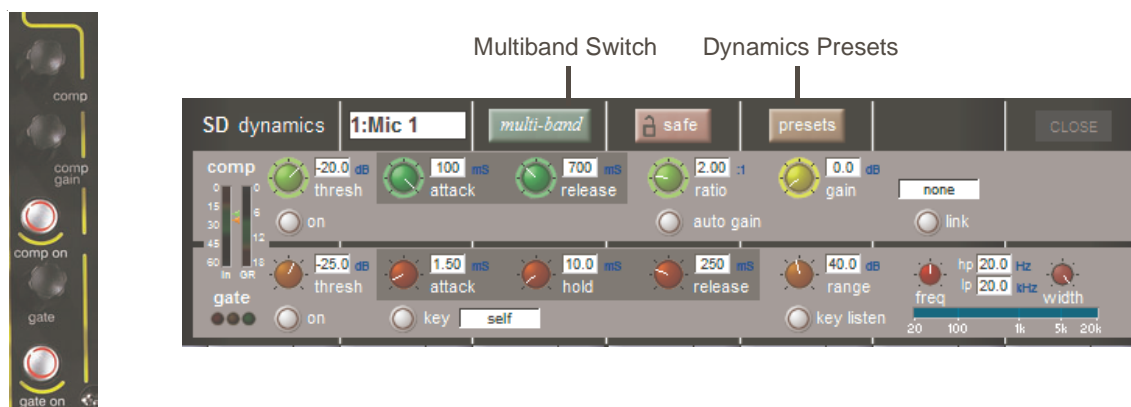

On mono channels, there is also a **link** button to the right of the compressor controls, allowing two channels to be linked together as if stereo. In other words, the link button enables another channel signal's to be added to this compressor's control circuit input, and for this channel's signal to be added to the other channel's control circuit input. Pressing this button brings up a dynamics link display listing **Channels, Groups and Auxes signal groups** in the left-hand side. When one of these **signal groups** is selected, their available **signals** are listed in the right-hand side of the display. Select a signal to link to and close the display. The **link** button is ringed red and the linked channel's number and name is displayed in the box above it to indicate that there is a link present. To cancel the link, press the button again and deselect the link signal.

**Note that when a link channel has no name, the display repeats the channel number.**

Gates can be keyed by a different signal by pressing the **key** button below the **attack** pot. This brings up a **Gate Key Route** display from which a key input can be selected. Consecutive channel gates can be keyed by consecutive input signals using the **ripple channels** function. The key button is ringed red and displays the key input in the text box to its right to indicate that another signal is keying the gate. The key input signal can be auditioned by pressing the **key listen** button underneath the **range** pot.

Each pot has its value displayed to its right. These pots are automatically assigned to the worksurface encoders below the screen when the dynamics panel is expanded. When the display is expanded to three bands, each band is assigned by touching it on screen.

At the top of the **dynamics** display are two buttons marked **safe**, and **presets**. Touching **safe** adds the dynamics to that channel's list of channel safes. Touching **preset** brings up the **Presets** display which can be used to save and recall presets. The available parameters and ranges are:

**Compressor:**

<b>threshold</b>	(range: -60 to 0dB)	<i>(this pot is duplicated on the worksurface, labelled <b>comp</b>)</i>
<b>attack</b>	(range: 0.5 to 100mS)	
<b>release</b>	(range: 10mS to 10S)	
<b>ratio</b>	(range: 1:1 to 50:1)	
<b>gain makeup</b>	(range: 0 to 40dB)	<i>(this pot is duplicated on the worksurface, labelled <b>comp gain</b>)</i>

**Gate:**

<b>threshold</b>	(range: -60 to 0dB)	<i>(this pot is duplicated on the worksurface, labelled <b>gate</b>)</i>
<b>attack</b>	(range: 0.05 to 100mS)	
<b>hold</b>	(range: 2mS to 2S)	
<b>release</b>	(range: 5mS to 5S)	
<b>ratio</b>	(range: 0 to 90dB)	
<b>filter frequency</b>	(both high- and low-pass ranges: 20Hz to 20kHz)	
<b>frequency width</b>	(range: 0 to 19.48kHz)	

**Multi-band Compression**

Up to 4 Channels can have their compressor modules switched into Multi-band mode. A warning message will appear on screen if an attempt is made to use Multi-band dynamics on more than 4 channels.

On any channel (Input or Output), open the Dynamics Module and expand the dynamic controls using the multi-band button.



Each band includes all of the parameters as those found in the single band compressor. The link function remains available for the whole compressor, and is not assigned to any band. The bands can be switched on individually using the **on** buttons in the left-hand side of each band, or together using the **all on** button to the display's right.

**Note: When any band is switched Off, that Band will not pass audio.**

The crossover frequency between bands is controlled using the purple and red pots to the left of the **hi** and **lo** bands. Each crossover has a range of 20Hz to 20kHz, and the crossover frequencies are displayed below each pot. Each band can be auditioned by pressing the **listen** button below each **gain** pot which solo's that band to the mix (not the solo busses), in effect temporarily switching off the other bands.

The channel strip's compressor threshold and gain controls adjustment all three bands' controls, maintaining any relative offsets. The individual controls are mapped to the assignable rotaries below the screen.

**Note - Beyond the link function, the single and multi-band compressors have completely separate settings: No settings are copied between them, and the settings of each remain unchanged when the other is active. Note also, however, that multi-band and single band dynamics cannot both be active on one channel at the same time.**

Pressing **multi-band** again returns the compressor to single-band.

## Chapter 2 - Channel Types

### 2.9 LCD Functions

#### 2.9.1 Introduction to LCD Functions .....

The LCD functions are accessed by pressing the button located next to the rows of channel LCD displays. The LCD displays themselves provide information about the relevant channel and the current function mode is displayed in the bottom half of the display.

The Channel Select buttons beneath the LCD displays are used to activate the various functions and to select channels as required. Selecting one of these options assigns that function mode to the Channel Select buttons for all the channels within the **banks** associated with that **Lcd function** button.



There are nine different function mode options:

#### 2.9.2 Solo .....

When an **Lcd function** button is pressed, the left-hand LCD display is labelled **SOLO**. When **SOLO** mode is selected, the Channel Select buttons become solo buttons. The bottom half of the LCD display indicates which solo busses are available to the channel, as defined in the channel **Setup** display and the SOLO CHOICE function mode (described below). The button also displays whether each buss is AFL or PFL, as defined in the top-left corner of the master solo display.

In **SOLO** mode, the LCD displays are coloured according to their channel type when not soloed, and coloured green when soloed.

*Note that this is the default mode of the LCD displays, current when no other function modes have been selected.*

#### 2.9.3 Solo Choice .....

When an **Lcd function** button is pressed, the second LCD display from the left is labelled **SOLO CHOICE**. When this mode is selected, the Channel Select buttons are used to select the solo bus assignment for that channel, toggling between **1**, **2** and **1+2**.

In **SOLO CHOICE** mode, the LCD displays are coloured cyan.

#### 2.9.4 GANG .....

When an **Lcd function** button is pressed, the third LCD display from the left is labelled **GANG**. When this mode is selected, the Channel Select buttons are used for linking together all channel controls. All Channel Select buttons which are then pressed will have their controls linked. In the case of currently ganged channels, the Channel Select button can be used to remove them from their ganging group. The colour of the **GANG** symbols in the bottom left-hand corner of the on-screen channel display indicate what ganging groups exist: All faders which are ganged together will share one colour. Each time the **GANG Lcd function** is selected, a new ganging group is started, as indicated by the **GANG** symbols turning a different colour.

When channels are ganged together, operating any of their channel controls will cause all other channels within the ganging group to replicate that movement. Pan and phase controls are not included in gangs.

*Note that it is the level change associated with the fader movement which is replicated, not the physical distance the fader is moved.*

*Note also that gangs cannot be edited once they have been created - they must be cleared and created again.*

*Note also that when channel is muted, those channels within the ganging group which were already muted will stay muted. When the channel is then unmuted, all channels unmute, irrespective of whether they had been initially muted.*

Channels can be temporarily isolated from Gangs by pressing the Option button.

## 2.9.5 JOIN CG .....

When an **lcd function** button is pressed, the fourth LCD display from the left is labelled **JOIN CG**. When this mode is selected for a bank that contains the blue Control Group channel strips, the Channel Select buttons are used for assigning channels to Control Groups.

Control Groups enable a number of channel output levels and mute functions to be controlled from one master fader. They can include channels from all four channel types.

First, select a Control Group to Join by pressing the appropriate Channel Select button (the LCD display will show a tick symbol) and then press all of the Channel Select buttons that you wish to make members of that Control Group.

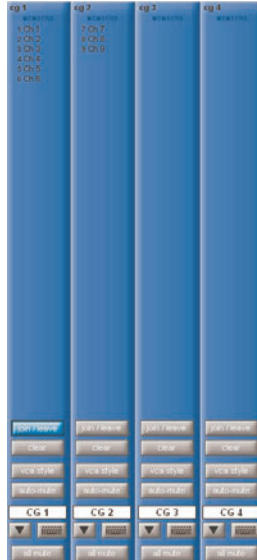

**Note that Control Group channels function completely differently from Group (GRP) channels: Group channels mix together the audio from any channels routed to them, whereas Control Groups simply allow adjustment of the levels of the channels to which are assigned to them, irrespective of any audio routing.**

A session can have up to 8 Control Groups. Control Groups can be named using the standard naming tools described in the Getting Started Section. The **safe** button, located at the bottom of the on-screen channel strip, can be used to protect the assignments and settings of the Control Group from being changed if a new Snapshot is fired.

### Control Groups Channel Assignments

To add or remove channels from a Control Group, enter **JOIN CG** function mode and press the Channel Select button on the Control Group channel to be edited. Alternatively, touch the **join/leave** button at the top of the button set in the Control Group channel's panel. All Channel Select buttons will now turn blue to indicate that they are in Control Group Join mode, and will display the number of the Control Group being edited in the bottom half of the button.

**Note that touching join/leave on one control group puts all channels into JOINCG mode.**

The LCD displays on any channel currently included in the group will display light blue. Press the Channel Select button to remove that channel from the group.

All other channel LCD displays will be dark blue, indicating that they are not currently included in the Control Group being edited. Pressing any of the Channel Select buttons will add them to the group.

All of the Control Groups to which a channel belongs are displayed immediately above the **GANG** and **SAFE** buttons in the Channel strip panel.

**Note that only the first two to three Control Group assignments within a channel can be displayed in the channel strip.**

All of the channels included in a Control Group are listed in the top half of its channel strip display.

To clear all of the channels currently assigned to a Control Group, touch the Control Group's **clear** button, located below the **join/leave** button, and press **Yes** in the warning display that appears.

## Chapter 2 - Channel Types

### Control Group Fader Modes

There are three modes in which the Control Group fader can interact with the faders of the channels assigned to it, and the button below the **clear** button in the channel strip display toggles between them:

In **moving fader** mode, all assigned faders will move to replicate any Control Group fader movements.

*Note that it is the level change associated with the fader movement which is replicated, not the physical distance the fader is moved.*

In **vca style** mode, moving the Control Group fader affects the output level of all assigned channels without moving their faders.

In **mute only** mode, the Control Group only controls the mute buttons of assigned channels, not the output level.

*Note that in all three modes, moving the fader of a channel assigned to a group does not impact the output levels of other channels within the group.*

### Control Group Mute Functions

The mute buttons within a Control Group interact in the same way, regardless of the current fader mode:

The mute button above the LCD display on a Control Group fader can be used to mute all of its assigned channels. Its function is duplicated by the **all mute** button below the channel's scribble strip. When deactivated, the Control Group mute button returns all assigned channels to their mute state before the Control Group mute button was activated.

The auto-mute function, activated by touching the **auto-mute** button located above the Control Group name in the Channel Strip panel, automatically mutes any channel which is removed from that Control Group and unmutes any channel that joins the Control Group.

### The Master Control Groups Display

In addition to the Control Group channel strips, an overview of all the Control Groups within a session can be access via the **Control Groups** menu button in the master screen.



This display consists of basic versions of each Control Group channel strip, including the channel assignments lists and a number of basic settings which can also be adjusted in the display: **join/leave**, **clear** and **all mute**. The Control Group naming controls are also available within the display's channel strips.

**2.9.6 Assign Faders** .....

To assign channels to the worksurface, enter **ASSIGNFADERS** mode. The LCD displays will turn dark green and their lower halves will read **ASSIGN**. Press the Channel Select buttons for each of the channel strips to which you wish to assign new channels.

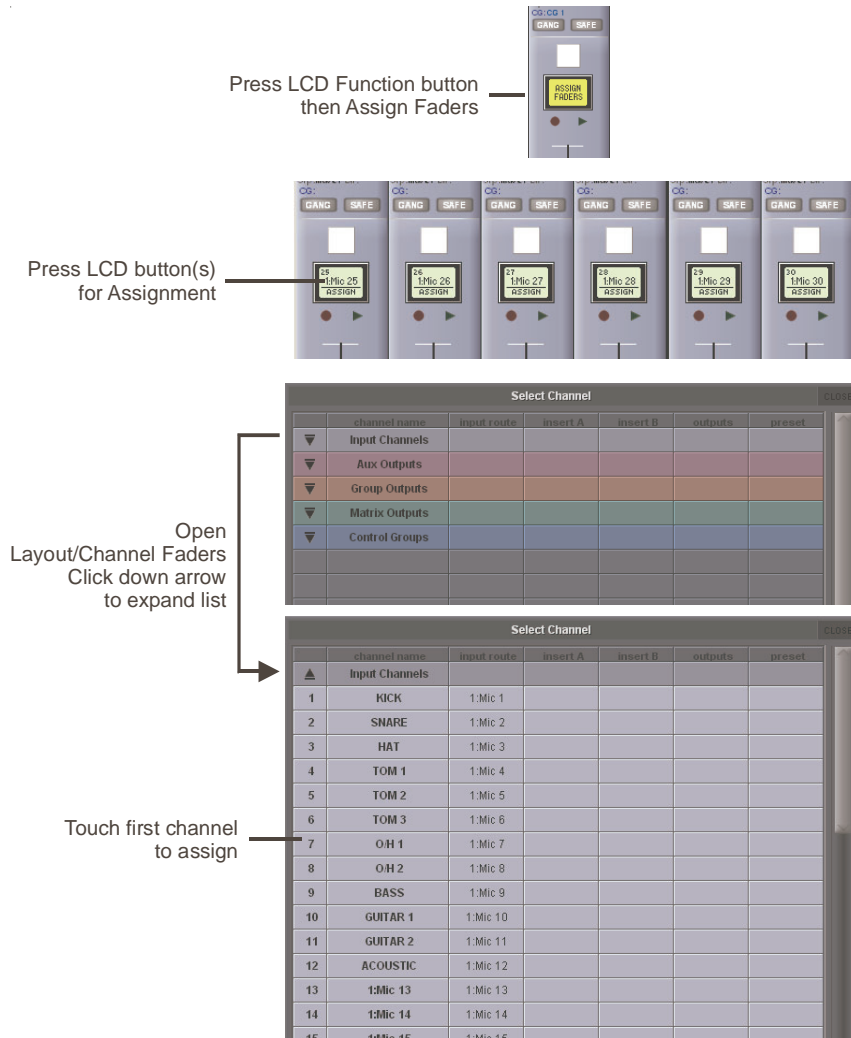

To select the channels you wish to assign to those channel strips, open up the **Channel List** display, accessed by going to the master screen and touching **Layout > Channel List**. There you will find a list of all input, output and control channels that are present in the session structure, grouped by channel type. Open up the channel list for the channel type of the first channel to be assigned by touching the appropriate down arrow in the left-hand column. The channel list can be scrolled using the scroll bar on the right of the display:

To assign one of the listed channels to the channel strip, simply touch the channel name in the list. The remaining channels can now be assigned in the same way, The channels selected in the **Channel List** display are assigned to the selected channel strips in ascending order, starting with the lowest channel in the bank.

**Note that the assign function is restricted to the currently selected bank.**

**Note also that when new channels are added to a session, or when a session is created, all of the existing channels can be assigned to the worksurface using the rebuild banks function within the Session Structure display.**

## Chapter 2 - Channel Types

---

### 2.9.7 Unassign Faders .....

To remove channel assignments from a channel strip, enter **UNASSIGNFADERS** mode. The LCD displays will turn dark green and their lower halves will read **UNASSIGN**. Press the Channel Select button for any channel strip you wish to clear, and the strip will go blank.

### 2.9.8 Copy Bank From .....

To copy a different bank of channels to the current bank location, press **COPYBNKFROM**. The message '**PRESS | A BANK | BUTTON | FOR | COPYIN | FROM**' will be shown across the LCD displays. Simply press the **bank** button for the bank which you want to copy to the current location.

### 2.9.9 Copy Bank To .....

To copy the current bank to different bank location, press **COPYBNKTO**. The message '**PRESS | A BANK | BUTTON | FOR | COPYIN | TO**' will be shown across the LCD displays. Simply press the **bank** button for the bank to which you want to copy.

### 2.9.10 Clear Bank .....

To clear all channels from a bank, press **CLEARBANK**. The message '**CONFIR | CLEAR | BANK: | YES | NO**' will be shown across the LCD displays. Press **NO** to cancel the action or **YES** to continue.

*Note - Banks can be moved between layers, and also between sections of the console.*

*Note also that the Fader Banks display on the master screen can also be used for altering the bank layout.*

*Note also that there is no undo function for these actions. Proceed with care!*



# **SD11 Operation Manual**

## **Chapter 3:**

### **The Master Screen**

# Chapter 3 - The Master Screen

This chapter describes all of the functions accessed from the Master Screen. The chapter focuses on the functions of the menu buttons across the top of the Master Panel, working through the buttons from left to right.

To open the Master screen press the worksurface **Master** button just below and to the right of the screen.

## 3.1 System Menu



### 3.1.1 Diagnostics .....

The **Diagnostics** display is explained in the Troubleshooting chapter.

### 3.1.2 Oscillator .....

The SD11's oscillator is configured in the **Oscillator** display.

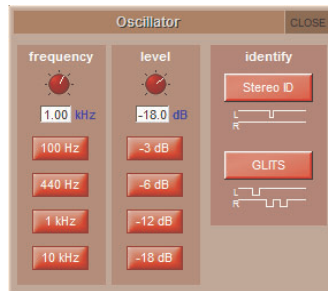

The frequency of the oscillator is controlled by the left-hand **frequency** pot, and its audio level is controlled by the right-hand **level** pot. The buttons below each pot, can be used to set the oscillator to standard frequencies (**100Hz, 440Hz, 1kHz, 10kHz**) and levels (**-3dB, -6dB, -12dB, -18dB**). The current value of each parameter is displayed below its pot.

For Stereo channels, the 1 KHz oscillator can be set to produce a pulsing ID signal on the left signal or a GLITS signal as indicated by the on-screen graphic.

### 3.1.3 Security .....

Security modes are selected in the system menu, with a choice of three levels of access:

- Setup:** Users have full access to every function on the console.
- Live:** Access to elements of the console can be limited, and password protected.
- Unattended:** The console is locked, and cannot be operated.

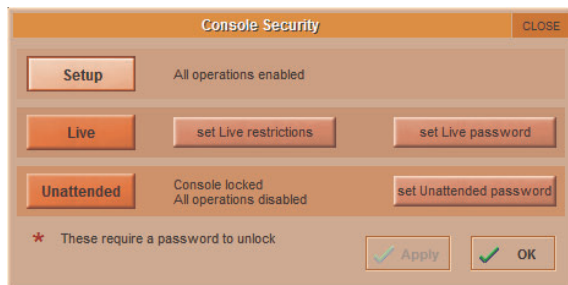

User passwords can be defined for the Live and Unattended modes. To set a password, press the **Set Password** button. Enter the old password then the new one twice, and press **OK**. By default, the passwords are blank.

A dialog box titled "Change Live Password" with a "CLOSE" button in the top right. It contains three input fields: "existing password", "new password", and "confirm new password". At the bottom right is an "OK" button with a green checkmark icon.

**NOTE:** If you should forget your password, call your Distributor to obtain a reset password. Entering the master override password will allow new passwords to be set.

To modify restrictions in Live mode, press the **Set Live Restrictions** button in the **Console Security** Panel. A range of parameters are shown, with a tick indicating that access is allowed and a cross that the item will be locked out in Live mode. Each group list can be expanded for item-specific restrictions by pressing on the down arrow in the left-hand column, as shown for **Matrix Outputs** below:

Live Security Restrictions													CLOSE
	channel name	input/trim	delay	filters	eq	dynamics	inserts	sends	fader	mute	panner	to groups	outputs
▼	Local I/O	✓											
▼	Rack 1	✓											
▼	MADI	✓											
▼	Input Channels	✓	✓	✓	✓	✓	✓	✓	✓	✓	✓	✓	✓
▼	Aux Outputs	✓	✓	✓	✓	✓	✓		✓	✓			✓
▼	Group Outputs	✓	✓	✓	✓	✓	✓		✓	✓		✓	✓
▼	Matrix Inputs	✓						✓					
▲	Matrix Outputs	✓✗	✓	✓	✓	✓	✓		✓	✓			✓
	M1 PA Left	✓	✓	✓	✓	✓	✓		✓	✓			✓
	M2 PA Right	✓	✓	✓	✓	✓	✓		✓	✓			✓
	M3 Matrix 3	✓	✓	✓	✓	✓	✓		✓	✓			✓
	M4 Matrix 4	✓	✓	✓	✓	✓	✓		✓	✓			✓
	M5 Matrix 5	✗	✓	✓	✓	✓	✓		✓	✓			✓
	M6 Matrix 6	✗	✓	✓	✓	✓	✓		✓	✓			✓
	M7 Matrix 7	✗	✓	✓	✓	✓	✓		✓	✓			✓
	M8 Matrix 8	✗	✓	✓	✓	✓	✓		✓	✓			✓
▼	FX	✓											
▼	Graphic EQ				✓								

change Control Group members	<input type="checkbox"/>	change Snapshots	<input type="checkbox"/>	change Audio I/O devices	<input type="checkbox"/>
change Gang members	<input checked="" type="checkbox"/>	change Channel Presets	<input checked="" type="checkbox"/>	change Audio Sync	<input checked="" type="checkbox"/>
change Bank Layouts	<input checked="" type="checkbox"/>	change FX Presets or types in use	<input checked="" type="checkbox"/>	Quit to Windows	<input checked="" type="checkbox"/>
change Session Structure or overwrite files		<input checked="" type="checkbox"/>			

# Chapter 3 - The Master Screen

## 3.1.4 Clear Over Indicators .....

Pressing this entry in the **System** sub-menu clears all peak LED's from the on screen meters.

## 3.1.5 Overview Clear Screen .....

Some panels such as the information bar and the status indicators can be dragged with the trackball to external overview screen. To quickly reset the position of these panels back to the Master screen, press the **Overview Clear Screen** button.

## 3.1.6 Keyboard Help .....

The Keyboard Help button opens up a display detailing the console control elements which are available via an external keyboard:

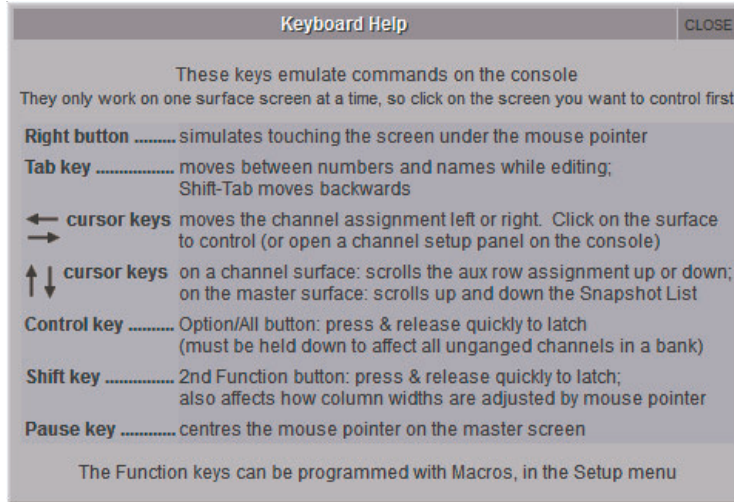

## 3.1.7 F10: Reset FX .....

Pressing this entry in the **System** sub-menu will reset the FX module audio. This allows, for example, lengthy delay and reverb tails to be killed. To complete the reset, select **Yes** in the warning pop-up which appears.

*Note that this will briefly bypass all of the FX units.*

## 3.1.8 F11: Reset Engine .....

Pressing this entry in the **System** sub-menu will restart the audio engine

*Note that this will briefly interrupt the audio - do not use this function unless absolutely necessary.*

## 3.1.9 F12: Reset Surfaces .....

Pressing this entry in the **System** sub-menu will reset all of the worksurface controls. This function will briefly interrupt the audio on the Local I/O only.

## 3.1.10 Set Date & Time .....

Pressing this entry in the **System** sub-menu will open the Date and Time window for the console's operating system.

## 3.1.11 Shutdown .....

Pressing this entry in the **System** sub-menu shuts the console's control computer down. If the session is not saved, pressing **Shutdown** will bring up a warning display. Press **Yes** to shut down without saving, or **No** to cancel the shut down.

### 3.2 Files Menu

Files
Session Structure
Load Session
Save Session
Save As new file
Load Presets
Save Presets
Global Set to Defaults
Session Notes
Session Report

#### 3.2.1 Session Structure .....

Touching on **Session Structure** in the **Files** menu brings up the **Session Structure** display. This is where a session is named and where the buss allocation for the session is configured. While changes to session structure can be made once a session has been started, it is best to try and set these parameters before configuring the session. Session Structure changes are not implemented until the **Restructure** button in the bottom right-hand corner of the display is pressed.

To name the session, touch the **session title** box, type the session name using either the on-screen or external keyboard, and press **OK**.

Below the session title, each channel type has its own setup row, which includes **clear all** and **auto-route** buttons, and a display of the current number of channels in the session. To adjust the quantity of aux or group busses, touch on the associated channel count box, and either enter a number using the pop-up number keypad, or adjust using the assigned Touch-Turn controller. There are a total of 12 Mono or Stereo busses available. The **spare channel processing** box at the bottom of the display shows the number of processing channels still available, and the **spare busses** box to its right shows the number of output channels still available.

The screenshot shows the 'Session Structure' screen with the following annotations:

- Touch numbers to edit with pop-up keypad or touchturn:** Points to the channel count boxes for input channels, aux busses, and group busses.
- Enter Session title:** Points to the 'session title' input field.
- Set number and type of Aux:** Points to the 'aux busses' row, specifically the channel count and type (Mono, Stereo, LCR) options.
- Set number and type of Group:** Points to the 'group busses' row, specifically the channel count and type options.
- Automatically route inputs/outputs when using the Clear function:** Points to the 'clear all' buttons for various channel types.
- Create a default session with flat parameters and basic routing:** Points to the 'DEFAULT ALL' button.
- Option to Clear parts of the session when restructuring:** Points to the 'clear all' button for 'comms'.
- Total number of unallocated processing:** Points to the 'spare channel processing' box at the bottom, showing the value '1'.
- Total number of spare busses:** Points to the 'busses' box at the bottom, showing the value '1'.

**Note - Pressing the Default All button followed by the Restructure button will automatically configure a new session with the following setup where the first 32 rack inputs are routed to input channels 1-32 and the Master Buss is routed to Local outputs 1 & 2 . All input channels will be routed to the Master Buss and the console headphones will be fed by the Master Buss when nothing else is soloed.**

# Chapter 3 - The Master Screen

---

The default configuration is:

- 32 input channels (Fixed); (Note that 8 of these can be made stereo)
- 3 Mono Aux busses & 3 Stereo Aux busses (Adjustable);
- 3 Mono Group busses & 3 Stereo Group busses inc 1 Stereo Master Buss (Adjustable);
- 8 Matrix Inputs and 8 Matrix Outputs (Fixed);
- 8 Control Groups (Fixed);
- 2 Solo Busses (Fixed) (Note that these can be mono, stereo or LCR).

If an LCR Buss exists within the session, it is automatically made the Master buss, with the **Master Level** encoder automatically assigned to it.

If the **clear all** button is pressed, any non-default routing or processing (EQ, dynamics etc) will be cleared from the channels in the session when the **Restructure** button is pressed. This is especially useful when restructuring an existing session to make a new session.

The **auto-route** button automatically routes the physical inputs and outputs in the rack to the inputs and output channels in the session when the **Restructure** button is pressed, thus saving the operator from manually routing them in the channel **Setup** and **Output** displays. For example, auto-routing 32 inputs will route the first physical input (eg 1: Mic 1) to input channel 1, the second physical input (1: Mic 2) to input channel 2 until you either run out of inputs or channels. Auto-routes are as follows:

- Input Channels auto-route with physical inputs
- Aux, Group and Matrix Channels auto-route to physical outputs
- Matrix Inputs auto-route with group outputs

Auto-routing can only be used in conjunction with the **Clear All** button, and is not available for input channel direct outs. The outputs of Aux, Group and Matrix channels are auto-routed in sequence: Aux outputs followed by Group outputs, followed by Matrix outputs. As Control Groups include no signal routing, there is no control groups **auto-route** button.

**Important Note: auto-routing overwrites any previous input and output routing.**

The send point for input channel direct outs can be set globally using the **direct sends** button toward the top right-hand corner of the display. The button is made active by touching the input channels **Clear All** button. The **direct sends** button then toggles between **Post-Fader**, **Pre-Fader** and **Pre-Mute**.

Similarly, the send point for aux channel outputs can be set globally using the **aux sends** button to the left of the **direct sends** button. The button is made active by touching the aux busses **Clear All** button. The **aux sends** button then toggles between **Post-Fader**, **Pre-Fader** and **Pre-Mute**.

The **audio i/o** and **comms** rows beneath the standard channel-type rows allow the settings of the audio io cards and talkback function to be reset.

The **clear snapshots** and **clear macros** buttons towards the bottom-right of the window can be used to clear any existing snapshots and macros when making a new session.

**Note that the clear automation and comms auto-route functions have not yet been implemented.**

The **Rebuild Banks** button to the right of the **clear snapshots** button enables changes in the Session Structure display to be reflected in the layout of the console's layers and banks. If you restructure the session without rebuilding banks, any additional channels you have allocated are not placed on the worksurface, and need to be manually assigned to faders. If however, you press **Restructure** with **Rebuild Banks** enabled, the worksurface will be rebuilt with all channels being made available on the worksurface.

**Note that when Rebuild Banks is used, any non-default configuration of the channel layout is lost.**

To implement changes in the **Session Structure** display touch the **Restructure** button in the bottom right-hand corner. To exit the display without implementing the changes, touch **Cancel**, located below the **Restructure** button.

To clear unimplemented changes from the display, touch **REVERT**, located in the top left-hand corner of the display.

## 3.2.2 Load Session .....

Touching this entry in the **File** menu opens the **Load Session** display. The left-hand column of the display shows the file directory. At the top of the directory are two buttons which switch the list of folders below them between the contents of the console computer's **internal d:/Projects** folder and the contents of a **removable** USB drive. Each folder can be expanded by touching the + symbol to its right. The list can be scrolled using the scroll bar to its right.

When a folder or sub-folder in the left-hand directory is touched, a list of the session files contained within it appears in the list in the centre of the screen. The list displays the **Filename**, creation **Date & Time**, and **Description** of the session. In addition, the list also displays the number of **Inputs**, **Auxes** (mono, stereo), **Groups** (mono, stereo) and **Matrix** channels (ins/outs).

To load a session, touch the session in the list and press **Load**, located in the bottom right-hand corner of the display. To close the display without loading a session, press **Cancel**, located below the **Load** button and also found in the top right-hand corner of the display.

Once a session is loaded, a summary of the currently loaded session is displayed in the **Session:** display in the background of the master panel. Once any changes have been made to the session, the **File:** indication in this display will only show the folder of the most recently saved session, not the file name.

**Note that the BU column, set backup and copy backup buttons, have not yet been implemented.**

**Note also that if any of the buttons in the right-hand column of the window are active, sessions cannot be selected from the list.**

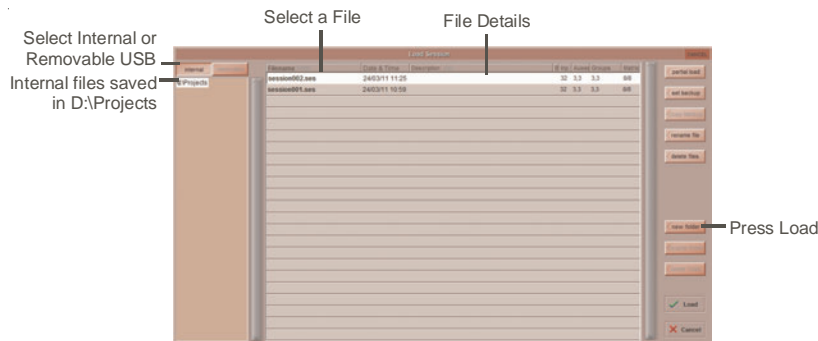

### 3.2.3 Save Session .....

Touching this entry in the **File** menu saves the current session. Once the session has been saved, a confirmation pop-up appears displaying the location of the saved session file.

Note that this function overwrites the most recently saved session. If you want to retain the most recently saved session, save the current session as a new session.

### 3.2.4 Save As New File .....

Touching this entry in the **File** menu opens the **Save Session** display. At the top of the display are two text boxes showing a **file name** and **session title**. The **file name** will normally be 'sessionxxx.ses' where xxx is an auto-incrementing number and the **session title** is the same as the current session. If the session has not been changed since it was last saved, the file name will be the same as the current session. To edit the **file name** and **session title**, touch the relevant text box, enter the new name or title in the on-screen or external keyboard, and press **OK**. To overwrite another session, or to save the session in a new folder but with a previously used name, touch the session of that name and its name will appear in the **file name** box.

The location of the session file to be saved is defined in the directory in the left-hand side of the display. At the top of the directory are two buttons which switch the list of folders below them between the contents of the console computer's **internal** d:\Projects folder and the contents of a **removable** USB drive. Each folder can be expanded by touching the + symbol to its right. The list can be scrolled using the scroll bar to its right. Touch the button and folder within which you want to save the session.

To create a new folder, select the location for the folder in the way described above, touch the **new folder** button in the right-hand side of the display, type the folder's name using the external keyboard and press the external keyboard's return button. To rename a folder, touch the folder within the directory, touch the **rename folder** button in the right-hand side of the display, type the folder's new name using the external keyboard and press the external keyboard's return button.

To delete a folder, touch the **delete folder** button in the right-hand side of the display, touch the folder to be deleted and touch **Yes** in the confirmation pop-up which appears.

**Note that this action cannot be undone.**

Once the session has been named and its save location has been selected, save the session by pressing **Save**, located in the bottom right-hand corner of the display. To close the display without saving, press **Cancel**, located below the **Save** button and also found in the top right-hand corner of the display. If you attempt to save the session under a file name which already exists within that folder, a pop-up appears, warning that continuing will cause the file with that name to be overwritten. Touch **Yes** to continue, **No** to cancel.

**Note that overwriting the most recently saved session can be performed more quickly using the Save Session function described above.**

Once the session has been saved, a confirmation pop-up appears displaying the location of the saved session file.

To rename a file, touch the file to be renamed followed by **rename file**, located in the right-hand side of the display, enter the new name into the on-screen or external keyboard and press **OK**. If **rename file** is pressed without a file being selected, the first file in the list will be automatically selected for renaming.

**Note that the file name is the only file element that can be edited once the file has been saved.**

To delete files, select the folder containing the files to be deleted and touch **delete files**. To delete all files in the folder, touch **select all**, followed by **confirm delete**. To delete one file or a selection of files, touch the files you wish to delete followed by **confirm delete**. To



# Chapter 3 - The Master Screen

delete a consecutive range of files, touch **select range**, touch the first and last files included in the range to be deleted, and touch **confirm delete**. To complete the deletion process, touch **Yes** in the confirmation pop-up which appears.

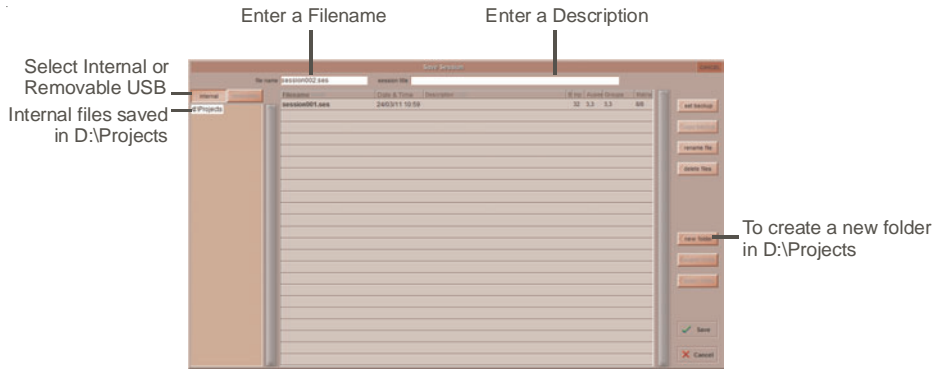

**Note that the set backup and copy backup functions have not yet been implemented.**

### 3.2.5 Load Presets .....

Touching this entry in the **File** menu opens the **Load Presets** display. This allows Channel, FX, Graphic EQ and Matrix presets created in other sessions to be imported into the current session. The left-hand column of the display shows the file directory. At the top of the directory are two buttons which switch the list of folders below them between the contents of the console computer's **internal** d:/Projects folder and the contents of a **removable** USB drive. Each folder can be expanded by touching the + symbol to its right. The list can be scrolled using the scroll bar to its right.

When a folder or sub-folder in the left-hand directory is touched, a list of the Preset files contained within it appears in the list in the centre of the screen. The list displays the **Filename**, creation **Date & Time**, and **Description** of the preset file. In addition, the list also displays the number of **Input**, **Out** (fx), **GrEQ** (Graphic EQ) and **Matrix** presets contained within the preset file.

To load a set of presets, touch the preset file in the list and press **Load**, located in the bottom right-hand corner of the display. To close the display without loading a session, press **Cancel**, located below the **Load** button and also found in the top right-hand corner of the display.

**Note that a session's presets are loaded as part of the session file.**

**Note also that the set backup and copy backup functions have not yet been implemented.**

**Note also that if any of the buttons in the right-hand column of the window are active, sessions cannot be selected from the list.**

### 3.2.6 Save Presets .....

Touching this entry in the **File** menu opens the **Save Presets** display. At the top of the display is a text box showing the **file name** of the most recently created presets file. It will normally be 'presetsxxx.pre' where xxx is an auto-incrementing number. To edit the **file name** touch the text box, enter the new name or title in the on-screen or external keyboard, and press **OK**. To overwrite another file, or to save the file in a new folder but with a previously used name, touch the file of that name and its name will appear in the **file name** box.

The location of the presets file to be saved is defined in the directory in the left-hand side of the display. At the top of the directory are two buttons which switch the list of folders below them between the contents of the console computer's **internal** d:/Projects folder and the contents of a **removable** USB drive. Each folder can be expanded by touching the + symbol to its right. The list can be scrolled using the scroll bar to its right. Touch the button and folder within which you want to save the session.

Once the presets file has been named and its save location has been selected, save it by pressing **Save**, located in the bottom right-hand corner of the display. To close the display without saving, press **Cancel**, located below the **Save** button and also found in the top right-hand corner of the display. If you attempt to save the set of presets under a file name which already exists within that folder, a pop-up appears, warning that continuing will cause the file with that name to be overwritten. Touch **Yes** to continue, **No** to cancel.

**Note that a session's presets are also saved as part of the session file.**

**Note also that the set backup and copy backup functions have not yet been implemented.**

## 3.2.7 Global Set To Defaults .....

The **Global Set to Defaults** Panel, opened via the **File** menu, allows global settings to be applied to the console. Select the Channel type from the list on the left side of the panel, and then select the parameter to be reset from the list to the right.



The **undo** button in the top-left undoes all changes since the panel was opened. Once the panel is closed, changes cannot be undone.

## 3.2.8 Session Notes .....

The **File** menu **Session Notes** button opens a panel in which can be used for saving any important session information:

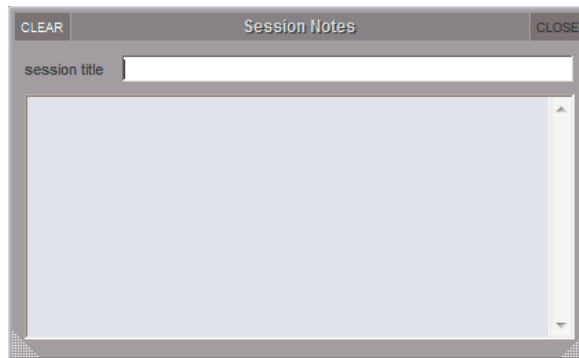

## 3.2.9 Session Report .....

In the **Files** menu there is also a **Session Report** button. This lists the session details on the master screen in an RTF compatible format. The **Save File** button at the top left of this panel will save the report in the D:\Projects as the session filename suffixed with .rtf.

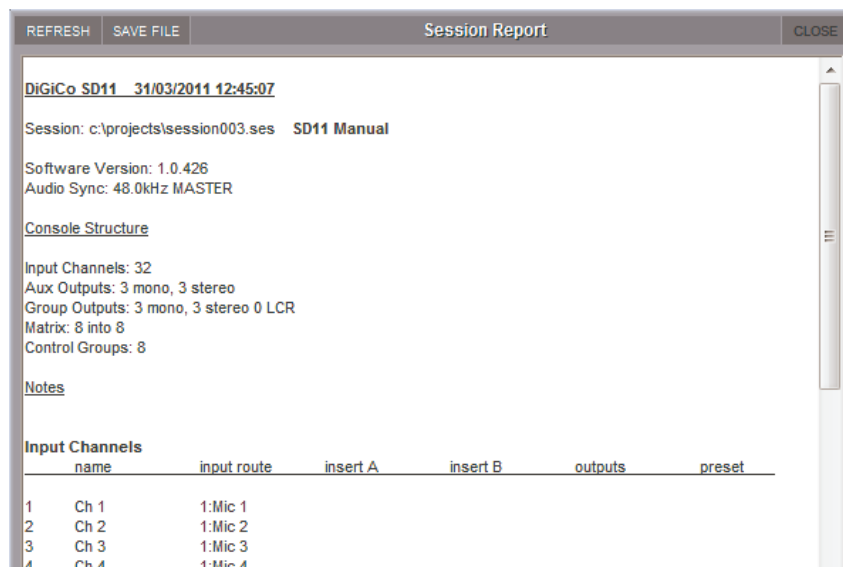

# Chapter 3 - The Master Screen

## 3.3 Layout Menu

### 3.3.1 Fader Banks .....

Touching on **Fader Banks** in the **Layout** menu brings up the **Fader Banks** display. This display allows the location of each fader bank to be altered. The bank buttons available within each section of the desk are displayed with their current fader set, with the left and right section banks on the left and right respectively. Towards the bottom of the display there are a number of grey function buttons which turn light-grey to indicate that they have been selected.

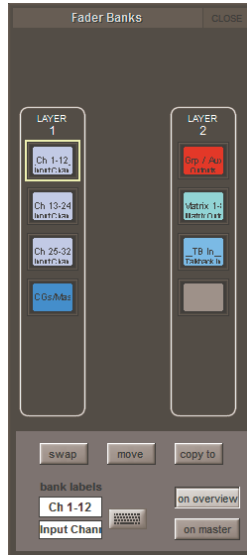

To swap the locations of two fader banks, touch one bank button so that it is highlighted in yellow, touch **swap** (located below the left fader bank's) and touch the other bank button.

To move a fader bank to a new location, highlight the bank you wish to move, touch **move** and touch the bank to which you wish to move it. If there is currently a fader bank in the destination bank, it will be overwritten.

To copy a fader bank to a new location, highlight the bank you wish to copy, touch **copy to** and touch the bank to which you wish to copy it. If there is currently a fader bank in the destination bank, it will be overwritten.

The labelling within the bank LCD displays can be edited using the text boxes in the bottom left-hand corner of the display. By default, the top row of the button displays a short version of the channel type (**Ch** for input channels, **Aux** for aux channels, **Grp** for group channels, **Matrix** for matrix channels and **CG** for control group channels) followed by the channel number range, and the bottom row displays the channel type in full. To edit the either row, touch its text box, type in the new name using the on-screen or external keyboard and press OK. The keyboard symbol to the right also activates the naming function for the top row.

**Note that this label affects the bank button displays, not the channel faders within the bank.**

### The Overview Display

A miniature graphic of each fader set can be displayed on the master screen, or on a separate screen connected to the **Overview** VGA output on the back of the console. These graphics display the fader position, mute, solo status and insert status, and the meter for the channels within all displayed banks. The parameters displayed in this overview can also be adjusted on the overview screen using the external mouse. The **on overview** and **on master** buttons, located below the **Fader Bank** display's master banks, are used to include and exclude fader banks from the external overview display and the master panel respectively.



## 3.3.2 Channel List .....

Touching on **Channel List** in the **Layout** menu brings up the **Channel List** display, containing a complete list of all the input, aux, group, matrix and control group channels which exist within the session. The channel list for each channel type can be accessed by touching the appropriate down arrow in the left-hand column.

Touching a channel entry on the list will show that channel to the worksurface.

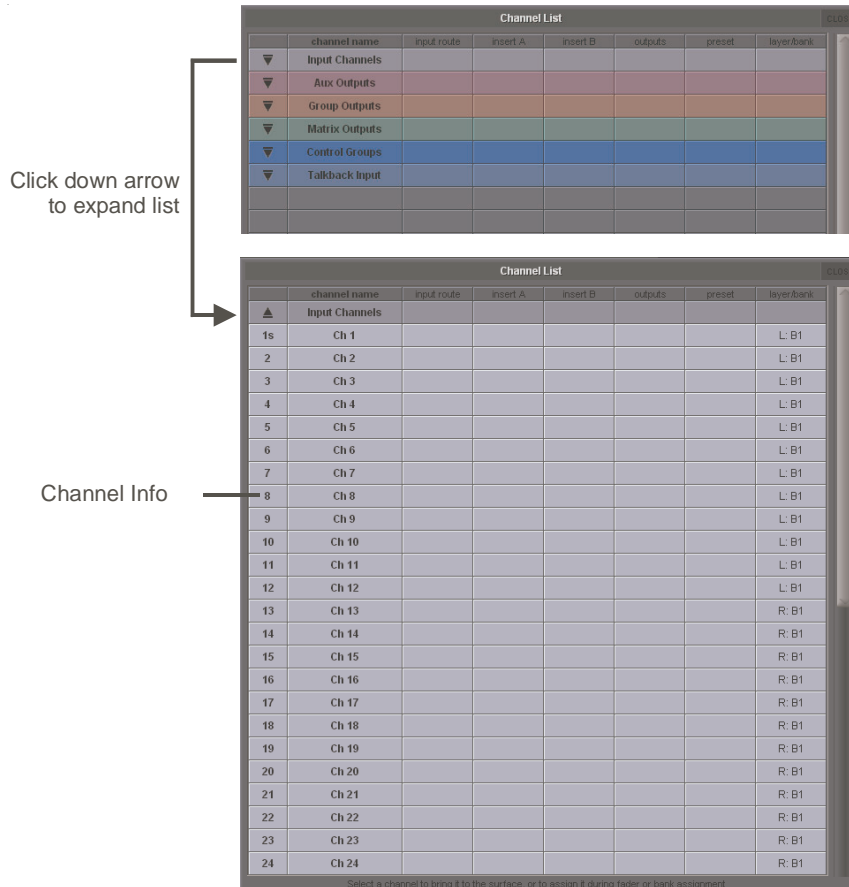

Primarily, the **Channel List** display is used for adjusting the bank assignments of the session's channels. This function employs the **COPY BANK FROM** LCD function mode, and is described in full in the Channel Types section of this manual.

**Note that when new channels are added to a session, or when a session is created, all of the existing channels can be assigned to the worksurface using the rebuild banks function within the Session Structure display.**

## 3.3.3 Transport Control .....

Touching on **Transport Control** in the **Layout** menu brings up a display of the transport control of an external playback device. Playback devices are controlled via the MIDI connector on the console's back panel. The incoming MTC is also displayed.



Note that control of external playback devices can be programmed within the **Snapshots** screen, as described later in this chapter.

# Chapter 3 - The Master Screen

## 3.4 Snapshots Menu

Any number of Snapshots of the entire current console settings can be stored and recalled using the **Snapshots** panel. (This is only limited by system memory) These Snapshots can be absolute or grouped with other snapshots. The recall scope of the snapshot (how many controls it will affect when fired) can be set by controller or by input channel.

To display the **Snapshots** panel, touch the **Snapshots** button at the top of the Master Screen.

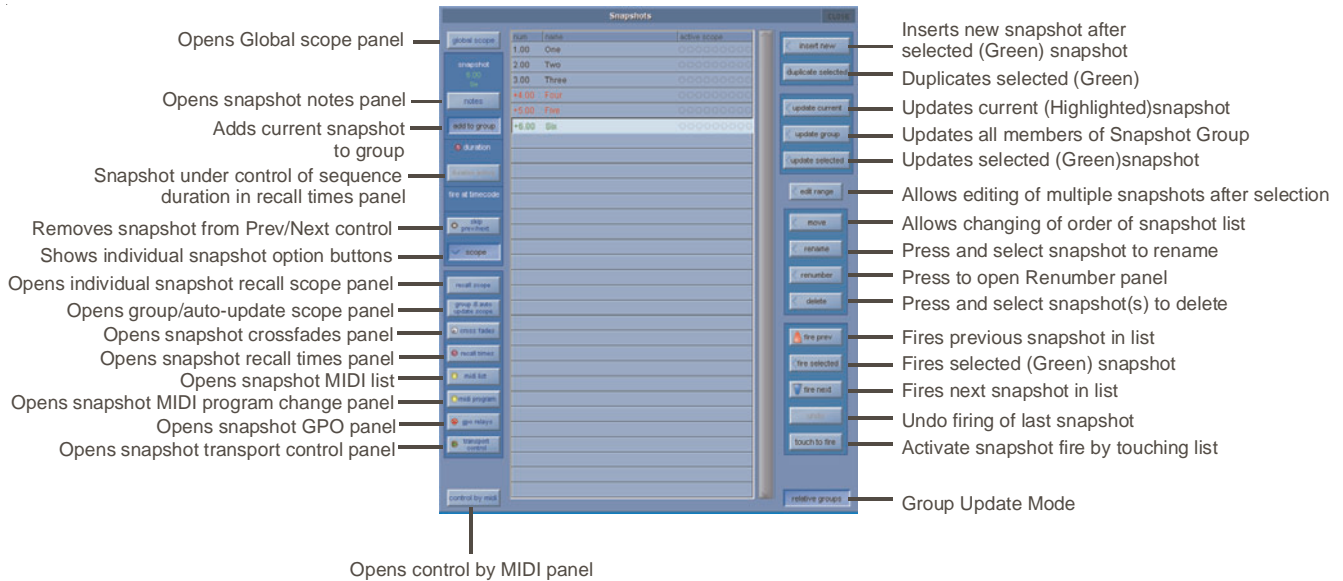

The current snapshot is highlighted light-blue in the panel. The name of the snapshot which is selected within the panel is displayed green. The **fire selected** button recalls this selected snapshot and highlights it in the screen list as the current snapshot.

If the current snapshot button shows an asterisk next to the number (eg. 001\*) this indicates that a controller has changed since the snapshot was fired.

If a Snapshot name appears in black in the list it is a standard Snapshot and if it appears in red or blue then it is a member of a group of snapshots

### 3.4.1 Storing a Snapshot .....

When a snapshot is stored all the console settings are saved but when the snapshot is recalled its effect can be limited to certain channels and controllers using the **Global** and **Recall Scopes** functions.

To store a snapshot of the current state of all the console controls, either touch the **Insert New** button or touch an unused row in the list. A new snapshot will be inserted below the currently selected (green) snapshot. You can then type a name for the snapshot.

Another method of creating a Snapshot is to press the **Duplicate Selected** button and this will create a copy of the selected (green) Snapshot.

**Note - If Duplicate Selected is used, the Snapshot that is stored may not reflect the current state of the console's controls - it will simply create a copy of the Snapshot that was selected when the button was pressed.**

### 3.4.2 Recalling a Snapshot .....

There are several ways to recall a snapshot:

- 1) Activate the **Touch To Fire** function using the button on the Snapshot panel and then touch the snapshot button you require.
- 2) The worksurface **Previous** and **Next** buttons on the right-hand side of the console worksurface can be used to step up and down the list firing snapshots in consecutive order:

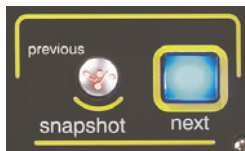

**The fire prev and fire next buttons in the Snapshots panel duplicate these buttons. Selecting the skip prev/next button in the panel for a Snapshot in the list causes that Snapshot to be skipped when the previous and next buttons are used.**

- 3) Snapshot firing can also be controlled by specific events on MIDI channel 16 (See Snapshots and MIDI).
- 4) Assign a **Macro** button to fire the Snapshot.

**3.4.3 Replacing a Snapshot .....**

To update or change a snapshot, set the console controls as required and then touch the **update current**, **update selected** or **update group** button.

**3.4.4 Editing Multiple Snapshots .....**

Individual controller changes can be written to several snapshots simultaneously using the **edit range** button. This does not replace the complete snapshot associated with the button.

When **edit range** is pressed, select individual Snapshots by touching them in the panel. You can also select all snapshots using the **select all** button which appears when **edit range** is selected, or select a contiguous range of Snapshots by pressing the **select range** button which appears followed by the first and last snapshots in the desired range.

*With the Edit button pressed, pressing the Snapshot buttons does not fire the snapshots.*

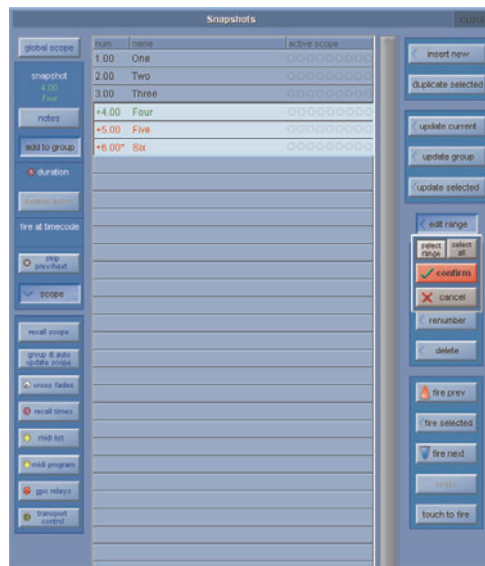

Having then performed any required edits, complete the operation by pressing the **confirm** button, or cancel it using the **cancel** button. The selection may be changed by pressing and releasing snapshot buttons at any time during the operation, so a variety of controllers or routes may be changed in a variety of snapshots.

The Snapshots window may even be closed to gain access to other editable functions - In this case, a warning message will appear to advise the user that they are still in snapshot edit mode.

While any Snapshot button is selected, changes to any snapshottable controller, routing changes, and any changes to the Snapshot Scope controls can be written to every selected Snapshot, overwriting the previous settings. For example, if Snapshots 1 and 2 are selected and the input gain for channel 1 is changed, subsequent recall of Snapshots 1 or 2 will set channel 1's input gain to the new value. Only channels which are altered while the Edit command is active will be affected and only in snapshots that are selected at the time.

*Note - Snapshot Scopes and Crossfade Times can also be edited for multiple Snapshots using the Edit Range function*

**3.4.5 Moving a Snapshot .....**

If you wish the Snapshot list to appear in a specific order, you may change the order of the list by moving the entries. Touch the **Move** button and then touch the Snapshot that you wish to move. You then touch the point in the list where the snapshot should be moved to.

**3.4.6 Renaming a Snapshot .....**

To rename a snapshot, touch the **Rename** button, then the name that you wish to change and enter a new name using the keyboard.

**3.4.7 Renumbering Snapshots .....**

As snapshots can be inserted at any point in the list you may find that you wish to renumber part or all of the list:

Press the **Renumber** button at the bottom of the snapshots panel and a new panel will open. Enter the range that you wish to renumber using the touch turn control or by touching the entry and typing and then enter the steps to renumber to (1.00 is the default value). Then press the **OK** button and the list will be adjusted accordingly.

**3.4.8 Deleting a Snapshot .....**

To delete a Snapshot, select the **delete** button, then select individual Snapshots by touching them in the panel. You can also select all snapshots using the **select all** button which appears when **delete** is selected, or select a contiguous range of Snapshots by pressing the **select range** button which appears followed by the first and last snapshots in the desired range. Confirm or cancel the operation using the **confirm** and **cancel** buttons.

## Chapter 3 - The Master Screen

---

### 3.4.9 Snapshot Undo .....

When a snapshot is fired, a separate hidden snapshot of the complete console is stored before the fired snapshot has its effect. If the Undo button is pressed, the hidden snapshot is fired using the same scope as the previously fired snapshot to undo its effect.

### 3.4.10 Snapshot Notes .....

Any important information pertaining to a specific Snapshot can be stored in the **Snapshot Notes** panel for any Snapshot. The notes panel is accessed by pressing the **notes** button in the main **Snapshots** window.

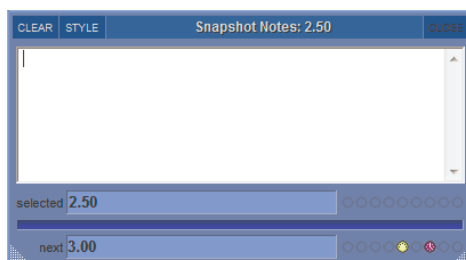

### 3.4.11 Snapshot Groups .....

A standard Snapshot (black entry in the list) is an absolute snapshot of the current state of all the console controls. A Snapshot can also be a member of a Group (red or blue entry in the list). Making Snapshots members of a Group allows all members of that Group to be updated together according to the Group Update mode that is selected.

To make a Snapshot a member of a Group, select the Snapshot in the list and press the **add to group** button on the left of the Snapshot panel.

**Note - Snapshots can only be members of the same Group if they are next to each other in the list. There can be several different groups of Snapshots in one list.**

If a Snapshot is a member of a Group, the colour of its entry in the list is determined by the current setting of the **Relative Groups** button in the bottom right of the Snapshots panel. This determines how the Group of Snapshots will be updated when **Update Group** is pressed.

- Red: Relative Update mode selected
- Blue: Non Relative Update mode selected

#### Relative Group Update Mode (Red entries)

If **Update Group** is pressed when the **relative groups** button is **active**, all dB controls such as faders and aux sends will be updated relatively. This means that if a fader is moved by +10dB in one snapshot, the same fader will be moved by +10dB in all Snapshots that are members of the same group, irrespective of the original level of that fader. So +10dB will be applied to the stored level of that fader in all of the Snapshots in the group.

Non dB controls such as Dynamics times, EQ Frequency & Q and Pans will only be changed in members of the group that had the same value for that control before it was moved. So, if one channel pan is in the same position in all the members of a group of Snapshots and you change one of them and press Update Group in Relative mode then the same channel pan will change in the same way in all the other snapshots that are members of that group. If however, any one of the Snapshots in the group has that channel pan in a different position to the current Snapshot then this one will not be changed when you press Update Group.

#### Non Relative Group Update Mode (Blue entries)

If **Update Group** is pressed when the **relative groups** button is not active then all controls behave in exactly the same way. Changes are only applied to the other Snapshots in the group if the controls that are being changed had the same value as the current Snapshot before the change was made. This is exactly the same behaviour as non dB controllers in Relative mode but in this case all controls are included.



## Group & Auto Update Scope

The behaviour of the Group Update function explained above is also dependant on the Global Auto Scope and the Group and Auto Update Scope settings that can be set per Snapshot for different types of controls.

Pressing the Global Scope button at the top left of the Snapshot panel opens the following display:

Global Snapshot Scope																								CLOSE
channel types	input/trim		delay		filters		eq		dynamics		inserts		sends		fader		mute		panner		to groups		outputs	
	recall	update	recall	update	recall	update	recall	update	recall	update	recall	update	recall	update	recall	update	recall	update	recall	update	recall	update	recall	update
Input devices	✗	✗																						
Input Channels	✓	✓	✓	✓	✓	✓	✓	✓	✓	✓	✓	✓	✓	✓	✓	✓	✓	✓	✓	✓	✓	✓	✓	✓
Aux Outputs	✓	✓	✓	✓	✓	✓	✓	✓	✓	✓	✓	✓	✓	✓	✓	✓	✓	✓	✓	✓	✓	✓	✓	✓
Group Outputs	✓	✓	✓	✓	✓	✓	✓	✓	✓	✓	✓	✓	✓	✓	✓	✓	✓	✓	✓	✓	✓	✓	✓	✓
Control Groups																								
FX	✓	✓																						
Matrix Inputs	✓	✓											✓	✓										
Matrix Outputs	✓	✓	✓	✓	✓	✓	✓	✓	✓	✓	✓	✓	✓	✓	✓	✓	✓	✓	✓	✓	✓	✓	✓	✓
Graphic EQ							✓	✓																
Output devices																							✓	✓

midi  gpo relays

Horizontal rows show the different sections of the console and the vertical rows show the Recall and Auto Update status for each of the different types of control. A red X indicates not included and a green tick indicates included. These settings can be changed individually by touching the X or tick symbols or by touching the name of a row or column to change all of its contents.

Recall Scope is dealt with in the next section but the **Auto scope** columns determine which controls will be included in the automatic group update. Any elements that have a red X will not be updated in any snapshots when **Update Group** is pressed.

In the picture above the Input Devices (rack and local input sockets) are not included in the Update scope so none of their gains or phantom power can be updated using the **Update Group** function. All other elements are ticked and therefore can be included in the **Update Group** function.

**Note - If elements are included in the Global Auto Scope they can still be prevented from Group Updating by the individual Snapshot's Group and Auto Update Scope.**

Selecting a Snapshot in the list and pressing the **Group & Auto Update Scope** button opens the following panel:

Group & Auto-Update Scope: Snapshot 1.00 One														CLOSE
channel name	input/trim	delay	filters	eq	dynamics	inserts	sends	fader	mute	panner	to groups	outputs		
0:Local I/O	✗													
1:Rack 1	✗													
2:Rack 2	✗													
Input Channels	✗	✗	✗	✓	✗	✗	✗	✓	✓	✗	✗	✗		
Aux Outputs	✗	✗	✗	✓	✗	✗		✓	✓				✗	
Group Outputs	✗	✗	✗	✓	✗	✗		✓	✓		✗	✗		
Control Groups								✓	✓					
Matrix Inputs	✗							✗						
Matrix Outputs	✗	✗	✗	✓	✗	✗		✓	✓				✗	
Graphic EQ				✓										
0:Local I/O													✗	
1:Rack 1													✗	
2:Rack 2													✗	

Press channel names to change whole row, column headings to change whole columns

control group members  gangs

This is very similar to the Global Scope panel but represents the Group and Auto Update Scope for one individual snapshot which is indicated by its name and number at the top of the panel.

In the picture above the only green ticks are in the EQ, faders and mutes columns and therefore all other elements are prevented from being affected by a Group Update in this particular Snapshot.

**Note - When using Snapshot Groups it is advisable to set the Global Auto Update scope before attempting to change the update settings for each individual Snapshot. Use of the Global Scope alone probably offers quite sufficient control for most common applications.**

# Chapter 3 - The Master Screen

## 3.4.12 Global Recall Scope .....

When a snapshot is stored all the console settings are saved but when the snapshot is recalled its effect can be limited to certain channels and controllers.

**Note - All elements of console channels and several other features such as Graphic EQ and Effects have their own SAFE settings. If any of these SAFE settings are active then the relevant controls cannot be affected by any Snapshots. This is in addition to the Global Scope settings described here.**

Pressing the **Global Scope** button expands the panel to display and edit the scope for all snapshots.

channel types	input/trim		delay		filters		eq		dynamics		inserts		sends		fader		mute		panner		to groups		outputs	
	recall	update	recall	update	recall	update	recall	update	recall	update	recall	update	recall	update	recall	update	recall	update	recall	update	recall	update	recall	update
Input devices	X	X																						
Input Channels	✓	✓	✓	✓	✓	✓	✓	✓	✓	✓	✓	✓	✓	✓	✓	✓	✓	✓	✓	✓	✓	✓	✓	
Aux Outputs	✓	✓	✓	✓	✓	✓	✓	✓	✓	✓	✓	✓	✓	✓	✓	✓	✓	✓	✓	✓	✓	✓	✓	
Group Outputs	✓	✓	✓	✓	✓	✓	✓	✓	✓	✓	✓	✓	✓	✓	✓	✓	✓	✓	✓	✓	✓	✓	✓	
Control Groups															✓	✓	✓	✓						
FX	✓	✓																						
Matrix Inputs	✓	✓											✓	✓										
Matrix Outputs	✓	✓	✓	✓	✓	✓	✓	✓	✓	✓	✓	✓	✓	✓	✓	✓	✓	✓	✓	✓	✓	✓	✓	
Graphic EQ							✓	✓																
Output devices																						✓	✓	

Horizontal rows show the different sections of the console and the vertical rows show the Recall and Auto Update status for each of the different types of control. A red X indicates not included and a green tick indicates included. These settings can be changed individually by touching the X or tick symbols or by touching the name of a row or column to change all of its contents.

The **Recall scope** columns determine which controls will be included in the Snapshot recall. Any elements that have a red X will not be recalled in any snapshots.

In the picture above the Input Devices (rack and local input sockets) are not included in the Recall scope so none of their gains or phantom power can be changed by firing Snapshots. All other elements are ticked and therefore can potentially be changed when a Snapshot is fired.

**Note - If elements are included in the Global Recall Scope they can still be prevented from recall by the individual Snapshot's Recall Scope.**

## 3.4.13 Individual Snapshot Recall Scope .....

Selecting a Snapshot in the list and pressing the **Recall Scope** button opens the following panel:

channel name	input/trim	delay	filters	eq	dynamics	inserts	sends	fader	mute	panner	to groups	outputs
0:Local I/O	X											
1:Rack 1	X											
2:Rack 2	X											
Input Channels	✓	✓	✓	✓	✓	✓	✓	✓	✓	✓	✓	✓
Aux Outputs	✓	✓	✓	✓	✓	✓		✓	✓		✓	✓
Group Outputs	✓	✓	✓	✓	✓	✓		✓	✓		✓	✓
Control Groups								✓	✓			
Matrix Inputs	✓						✓					
Matrix Outputs	✓	✓	✓	✓	✓	✓		✓	✓			✓
Graphic EQ				✓	✓							
0:Local I/O												✓

This is very similar to the Global Scope panel but represents the Recall Scope for one individual snapshot which is indicated by its name and number at the top of the panel.

In the picture above the only red crosses are in the input trim column for Local I/O and Rack 1 & 2 and therefore all other elements can potentially be recalled with Snapshots.

The controls that are included in each of the Recall Scope columns can be seen at the bottom of the panel when any of the entries are changed and are as follows:

## Controllers

- Input/Trim (Local I/O and Racks)** - input socket names, analogue gains, switches and phantom power
- Input/Trim (Input Channels)** - input routes, digital trim, phase and channel name
- Input/Trim (Aux Outputs/Group Outputs/Matrix Outputs)** - digital trim, phase, delays and buss name
- Input/Trim (Matrix Inputs)** - input routes and matrix input name
- Delay (All channel types)** - Channel delay
- Filters (All channel types)** - HPF and LPF
- EQ (All channel types)** - all controllers except channel HPF and LPF.
- Dynamics (All channel types)** - all controllers except stereo link.
- Inserts (All channel types)** - Insert Send & Return routes and ON/OFF switch
- Sends (Input Channels)** - Aux send levels, ON/OFF & PRE/POST switches and Aux pans
- Sends (Matrix Inputs)** - Matrix send levels and switches
- Fader (All channel types)** - channel fader.
- Mute (All channel types)** - channel mute
- Panner (Input Channels)** - channel pan
- To Groups (Input Channels)** - Input Channel to Buss routing switches
- To Groups (Group Channels)** - Group to Group routing switches
- Outputs (Input Channels)** - Direct output routes, direct gains and ON/OFF switches
- Outputs (Aux Outputs/Group Outputs/Matrix Outputs)** - Output routes and gains
- Outputs (Local I/O and Racks)** - output socket names, analogue output 10dB pads

## Misc

- CG Members** - Control Group label and a complete list of each group's members.
- Gangs** - Channel gang members.
- Banks** - Current assignment for all controllers on the worksurface.

### 3.4.14 Snapshot Crossfades .....

A crossfade time which is measured in seconds and frames can be applied to different controls in a Snapshot by adjusting the Crossfade Time in the Cross Fades panel. This crossfade occurs as you go into the Snapshot.

Select an individual time by touching it or select a column or row by touching its heading. Then enter a time in the Secs/Frames boxes at the bottom of the panel. Either touch and type or use the Touch Turn rotary to enter a figure.

Different Crossfade times can be applied to input trims, filters, EQs, dynamics, sends, faders and pans and these will apply to all of the channels in a given category eg All input channels. A value of zero switches it off.

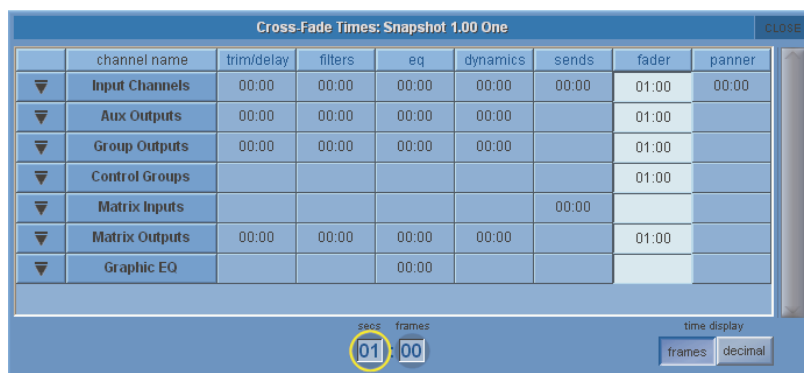



To change the default message for any particular snapshot, select the snapshot and press the **Change** button to select a specific available controller number. The **Clear** button will remove the existing message completely.

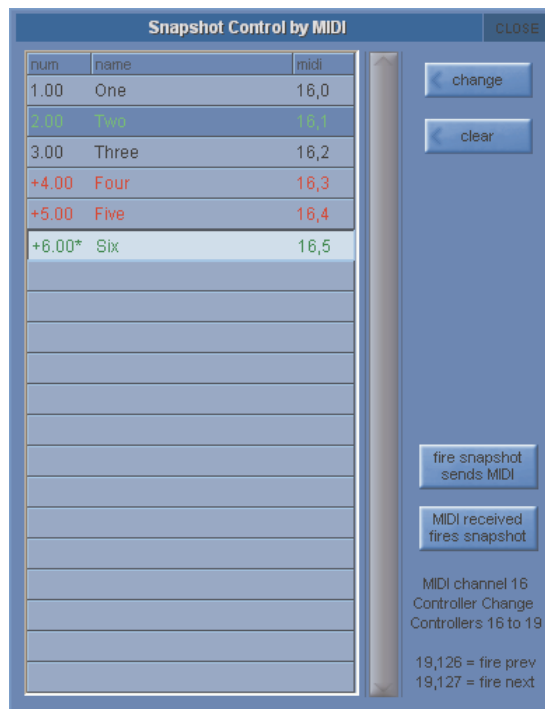

### 3.4.17 MIDI Devices .....

If you intend to send MIDI to external devices it is advisable to first define your receiving devices - this will make the programming of MIDI messages in Snapshots easier to achieve.

Press either the **Scope>MIDI Program** or the **Scope>MIDI List** button and then press the **Devices** button - the following panel will open:

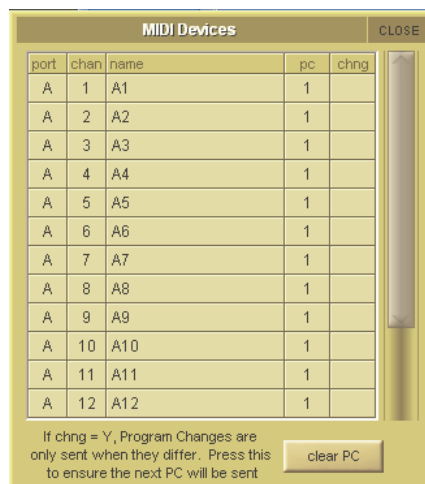

The SD11's built in MIDI port is referred to as Port A in the **Port** column. Set the receiving MIDI **channel** and **name** for each of your receiving devices and set 1 or 0 in the **PC** column according to whether the device uses 0-127 (0) or 1-128 (1) for its data values. If you don't know this piece of information then leave the setting as 1.

The column marked **Chng** determines whether Program Changes are only sent when they are different to the last sent message (Y) or whether they are always sent irrespective of the last message sent. This would be useful if there was no need to change the program on the receiving device and if you did this it might interrupt the signal passing through the receiving device as its program changes.

The **Clear PC** button at the bottom of the panel ensures that the next message will be sent.

This has defined your devices for later use and the panel can now be closed.

# Chapter 3 - The Master Screen

## 3.4.18 MIDI Program and MIDI List .....

The **Snapshot MIDI Program Changes** panel, accessed via the **midi program** button has a column for each of the 16 MIDI channels on Port A and a row for each existing Snapshot. Touch and type, use the value up/down buttons or enter a value using the **Touch Turn** rotary control for each program change that you wish to send with each snapshot and ensure that the **act** (active) box is ticked for each relevant Snapshot. With the **ripple down** button active, entries will be entered in all following Snapshots. Once entered, this MIDI information will be sent when the Snapshot is fired.

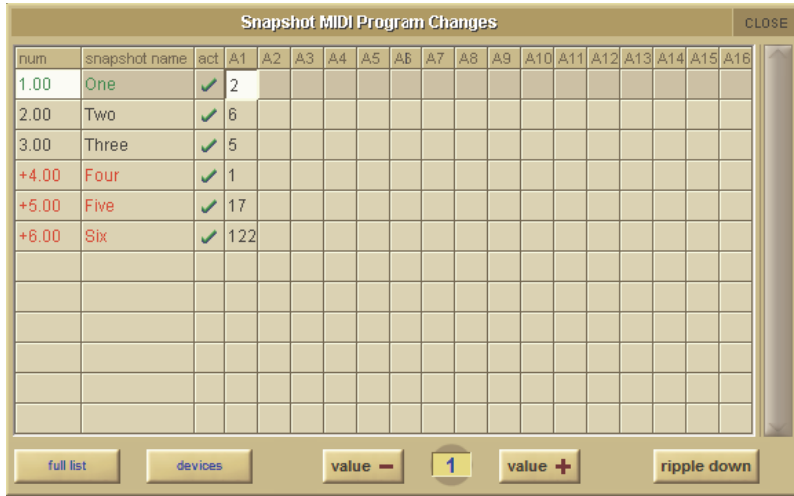

If MIDI program change messages have been entered in this way they will also appear in the **Scope>MIDI List** panel which allows entry and editing of other types of MIDI message.

There are columns for the **midi device** name (mentioned in the last section), the **MIDI Port**, **MIDI Channel**, type of **command** and two **data values**.

**Note - If you have already defined MIDI Devices, selecting one of these in the MIDI Device column will automatically enter the Port and MIDI channel that you have previously entered for that device.**

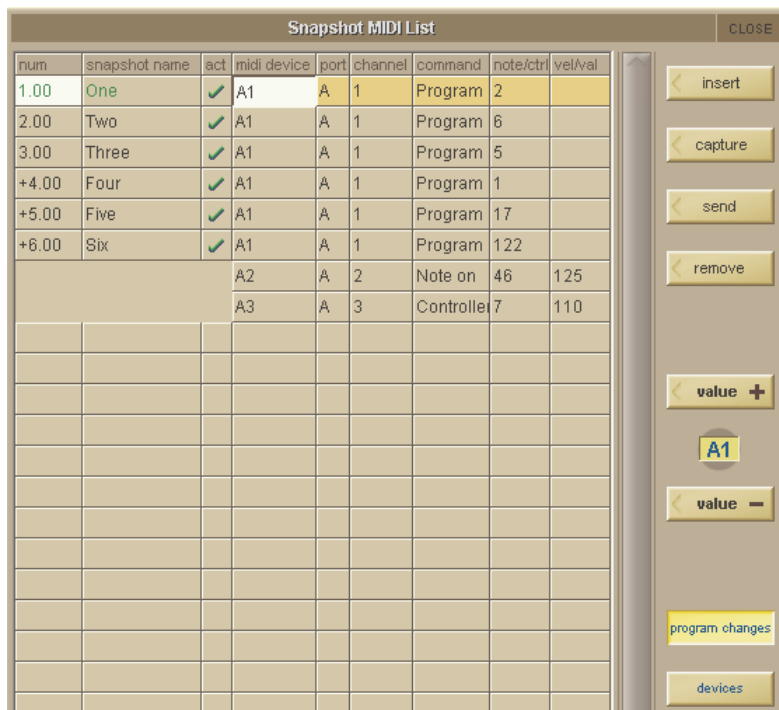

If you want to send multiple MIDI messages with a single Snapshot, use the **Insert** button to add extra lines for message entry. To test the MIDI message without firing the Snapshot, press the **Send** button - the display at the bottom right of the panel shows the presence of incoming and outgoing MIDI messages.

MIDI messages can also be automatically entered into the list by generating the required message from the external MIDI device, sending this to the console's MIDI In and pressing the **Capture** button.

**3.4.19 Snapshots & GPOs .....**

GPOs can be included as part of Snapshots, using the **GPO Relays** panel, opened using the **scope>gpo relays** button in the **Snapshot** window:

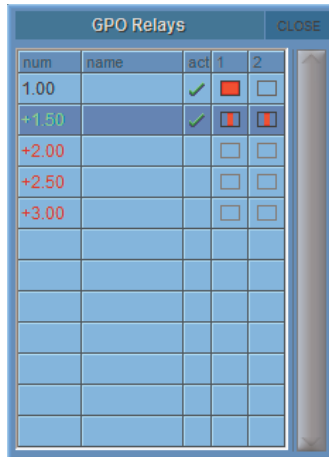

The GPOs are displayed in columns and the Snapshots in rows. Click on each box to change its state between the following:

- Blank (blue): GPO off
- Red box: GPO on
- Red line: GPO pulse (off-on-off)

Ensure that GPOs are active for the Snapshots in question, as indicated by a tick in the **act** column.

**3.4.20 Snapshots & MTC .....**

Snapshots can also be programmed to send MMC messages, allowing control of external playback devices. Within the snapshot **scope** section, press the **transport control** button. This opens the **Snapshot Transport Control** panel. The panel lists all current session snapshots and allows entry, per snapshot, of the following MMC commands.

- PLAY:** Basic Play command. External device will play from current location
- play from:** External device will play from specified time value
- play to:** External device will stop when the specified time is reached.
- locate to:** External device will Locate to specified time.
- STOP:** Basic Stop command. External device will stop.

Commands can be sent via MIDI, selected at the bottom of this panel.

**NOTE : Correct MMC operation relies on a correctly configured MIDI system, with MTC from the external device connected to the console MIDI Input. If this MTC connection is not present, the MMC snapshot system will not work.**

A Transport Control panel is also provided in the Layout Menu. This provides a MTC readout of incoming MTC, and allows direct control of the external device.

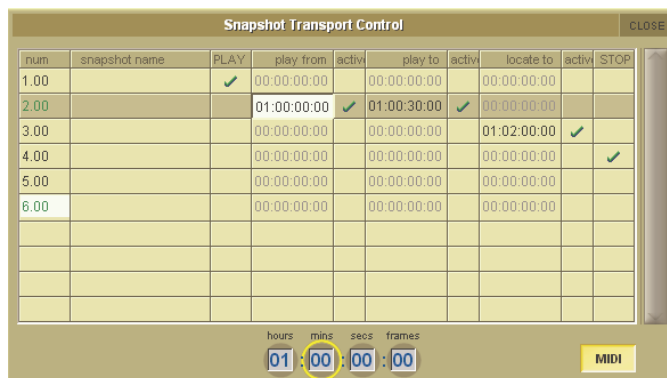



# Chapter 3 - The Master Screen

## 3.5 Options

The **Options** menu includes a variety of SD11 system preferences, grouped into eight tabs. Most functions are described fully within the display. Each function's button displays **Yes** in purple to indicate that it is active, and **No** in grey to indicate that it is inactive.

*Note that if Waves is enabled, the Options menu is located in the Setup drop-down menu. See the appendices for more details.*

### 3.5.1 Surface .....

The **Surface** tab includes settings related to the console screen, buttons and encoders:

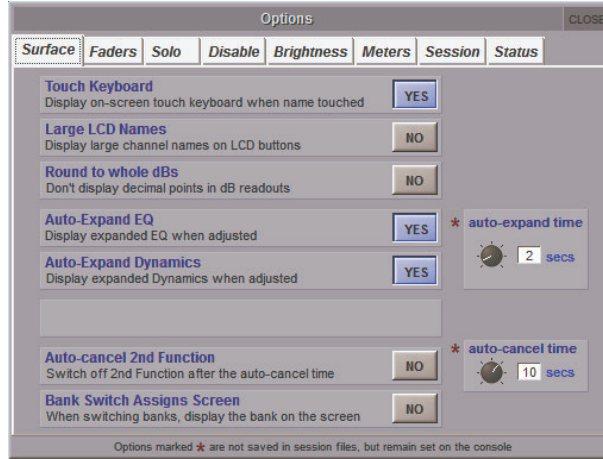

#### Touch Keyboard

This option defines whether or not the on-screen keyboard appears when a name box is touched. It is active by default.

#### Large LCD Names

This option allows the names in the LCD displays to be displayed in a larger font. It is inactive by default.

#### Round to whole dBs

Fractional dB values are rounded to the nearest integer value.

#### Auto Expand EQ

This option defines whether or not the EQ display opens when an EQ is adjusted. It is active by default.

#### Auto Expand Dynamics

This option defines whether or not the dynamics display opens when an dynamics is adjusted. It is active by default.

#### Auto Expand Time

This pot, located to the right of the **Auto Expand EQ** and **Dynamics** options, defines how long the EQ and dynamics displays remain open after the parameters within them are adjusted. The current setting is displayed in seconds, below the pot. Touching the pot assigns it to the Touch-Turn encoder.

#### Auto-cancel 2nd Function

This option defines whether or not active **2nd Function** buttons are cancelled after the time defined in the **auto-cancel time** pot to its right. It is inactive by default. Touching the pot assigns it to the Touch-Turn encoder.

*Note that both the auto-expand time and auto-cancel time values are set on the console and are not saved as part of the session file.*

#### Bank Switch Assigns Screen

This option defines whether or not pressing a bank button will automatically assign that bank to the screen. It is inactive by default.

### 3.5.2 Faders .....



#### Fader Assigns Channel

This option allows a channel to be assigned to the worksurface channel controls whenever it is touched. It is inactive by default.

**Note that when this option is active, accidentally touching a fader will assign it to the worksurface controls.**

#### Fader 0dB Detent

This option defines which controls have a detent at 0dB. Options are **None**, **Graphic EQ only** (default) and **ALL**.

#### Fader Touch Control

This option defines whether or not a fader moves when it doesn't detect a touch. Options are **Free** (fader moves freely) and **Protected** (fader is protected from moving without touch).

Note that this setting is set on the console and is not saved as part of the session file.

### 3.5.3 Solo .....

The **Solo** tab includes settings related to the console's solo functions:



#### Solo Displays Insert

This option defines whether or not the display of any FX or Graphic EQ inserted on a channel is opened when that channel's solo button is pressed. The Graphic EQ panel can only be displayed on the Master screen. It is active by default.

#### Solo Assigns Aux to Faders

This option defines whether or not the send levels to an aux channel are assigned to the channel faders when that aux channel's solo button is pressed. It is inactive by default.

#### Solo Assigns Aux to Rotaries

This option defines whether or not the send levels to an aux channel are assigned to the top row of aux encoders when that aux channel's solo button is pressed. It is inactive by default.

#### Solo Assigns Channel

This option defines whether or not a channel is automatically assigned to the channel worksurface controls when that channel's solo button is pressed. It is inactive by default.

#### Solo Assigns Channel Also Assigns Screen

If the Solo Assigns Channel option above is active this option defines whether soloing a channel will assign that channel's bank to the screen.

#### Solo Reverts to Output

This option defines what happens if an output channel solo is active when an input channel solo is then activated and deactivated. When this option is active, deactivating the input channel solo will return the solo buss to the output previously in solo mode. When this function is inactive, deactivating the input channel solo will leave all solos inactive.

The option is only available if the solo buss is in **single** mode. The option is inactive by default.

# Chapter 3 - The Master Screen

## 3.5.4 Disable .....

This tab is used for disabling **Snapshot Prev & Next** worksurface buttons. This function does not affect on-screen operation of the functions:

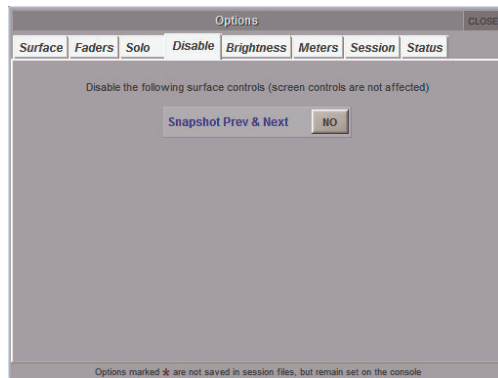

## 3.5.5 Brightness .....

The **Brightness** tab is used for setting the brightness of the console's **meter leds**, **lcd displays** and **surface leds**. Touching each pot assigns it to the Touch-Turn encoder.



## 3.5.6 Meters .....

The **Meters** tab includes settings related to the console meters:

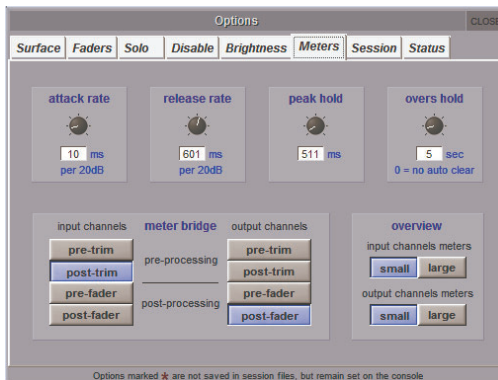

The four pots across the top half of the display affect the attack and release reaction time (**attack rate** and **release rate**), the **peak hold** time and the **overs hold** time. The current setting for each is displayed in either milliseconds or seconds, below each pot. Touching each pot assigns it to the Touch-Turn encoder.

**Note that when the overs hold time is set to 0, the hold time is set to infinite, not 0. The overs lights will therefore remain lit until they are manually cleared.**

The point being metered within the channel is set using the eight buttons in bottom left of the display. The input channel meters are adjusted using the buttons on the left, and the output channels are adjusted on the right. The options for each are **pre-trim**, **post-trim** (**pre-processing**), **pre-fader** (**post-processing**) and **post fader**. The default setting is **post-trim** for input channels, and **post-fader** for output channels. The currently selected button is displayed in purple.

The **Overview** area in the bottom right of the display allows the size of Input and Output Meters to be set: **small** or **large**.

**Note that the settings in the bottom half of the display affect the meters on the worksurface, not the on-screen meters.**

**3.5.7 Session** .....

The **Session** tab includes settings related to the console's startup procedure:



**Load Startup Session**

This option allows the startup session to be automatically loaded on system start up. When not selected, the desk will always start up in the default state.

**Save Startup Session**

This option allows the startup session to be automatically saved when quitting. When not selected, the desk will always start up in the same state.

**Default Positions**

This option allows all windows to be set to their default positions on next launch.

**Enable Waves MultiRack**

This option enables Waves features. Waves is an optional extra which provides a set of Waves plug-ins in addition to the console's own fx units. See the relevant appendix for more details, or contact DiGiCo if you are interested in purchasing waves.

**Enable Console Network**

This option activates networking for remote control PCs and consoles and is explained in the **Network and Mirroring** chapter.

**Mirroring Mode**

This option defines the way control is assigned between networked consoles and is explained in the **Network and Mirroring** chapter.

*Note that Enable Waves MultiRack and Enable Console Network both require a restart for changes to take effect.*

**3.5.8 Status** .....

The **Status** tab defines whether console status notifications are displayed. Both functions are active by default.

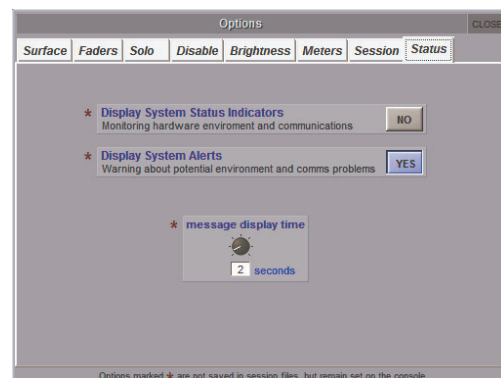

## Chapter 3 - The Master Screen

---

### Display System Status Indicators

This option defines whether or not the Status display is open. This display provides constant monitoring of various elements of the console's systems. The indication box to the right of each element displays a green **OK** when that element is running correctly, a red **ERR** when that element is in need of attention, and a blank grey box when that element is not relevant. Clicking on any indication box will bring up the appropriate Diagnostics page, if there is one.

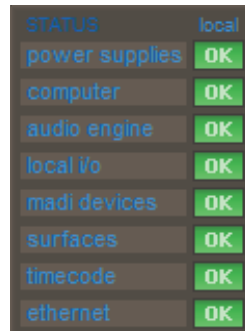

The screenshot shows a vertical list of system components with their status indicators. The word 'STATUS' is at the top left, and 'local' is at the top right. Below are eight rows, each with a component name and a status box. All status boxes are green and contain the text 'OK'.

Component	Status
power supplies	OK
computer	OK
audio engine	OK
local i/o	OK
madi devices	OK
surfaces	OK
timecode	OK
ethernet	OK

### Display System Alerts

This option defines whether or not system warnings are displayed. The time for which alerts are displayed is adjusted via the message display time pot, located towards the bottom of the window. The current setting is displayed in seconds, below the pot. Touching the pot assigns it to the Touch-Turn encoder.

### 3.6 Matrix Menu

#### 3.6.1 The Matrix Panel

Touching the **Matrix** menu opens the **Matrix Inputs** panel, which allows matrix inputs to be selected and the level of each input to each output to be set. Each column of the display represents an input to the matrix, and each row represents an output. Each pot within the display trims the signal coming from the input for that column, going to the output for that row.

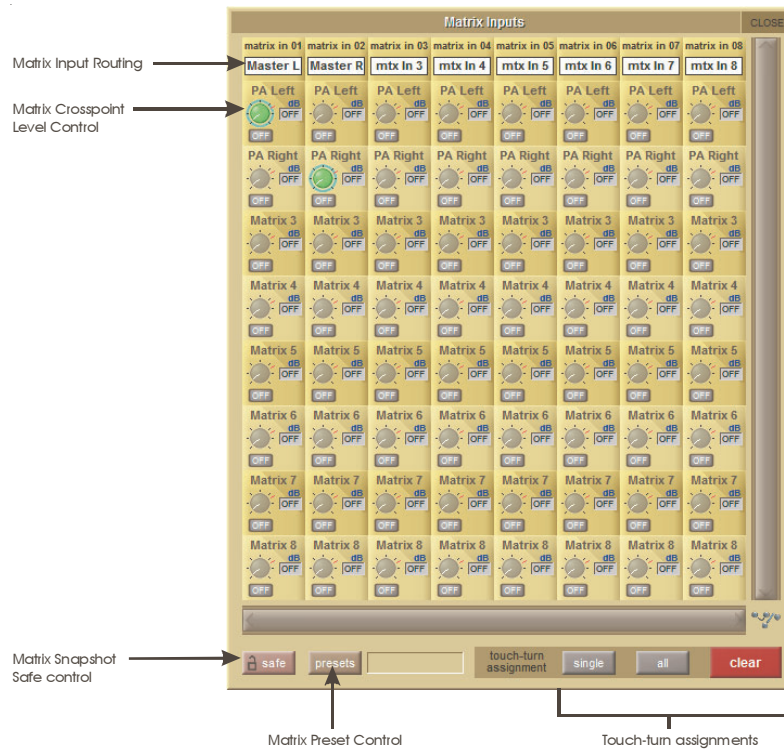

The top of each input column displays the input's name, and the label above each trim pot displays the pot's output. Touching any trim pot assigns it to the **Touch-Turn** encoder; pots lighten and are ringed green to indicate that they have been assigned. Multiple pots can be assigned simultaneously, in which case the encoder alters all assigned pots by the same amount, regardless of each pot's position. The value of each pot is displayed in dB to its right. Pots are switched on by touching the box below them, which displays **OFF** in grey when it is off, and **ON** in red when switched on. Turning a pot automatically switches it on.

There are three **touch-turn assignment** buttons at the bottom of the display. The **all** button assigns all the trim pots to the **Touch-Turn** encoder; individual pots can then be deselected by touching them. The **clear** button clears all the pots from the touch-turn encoder. Activating the **single** button prevents multiple trim pots from being assigned to the encoder simultaneously.

**Note that the all function can still be triggered when the single function is active.**

Matrix input signals are selected in the **Setup** display, accessed by touching the text box at the top of each input column. At the top of the **Setup** display, there is a text box which can be used for renaming the matrix input. Below that, there is a matrix input routing button which opens up a routing display. Routing displays are described in the Getting Started Section of this manual.

The **safe** button at the bottom of the **Matrix** panel protects the matrix settings from being overwritten by a snapshot recall.

The **Matrix Input Presets** panel is opened using the **presets** button located at the bottom of a matrix input **Setup** display and also at the bottom of the **Matrix** panel. Preset panels are described in full in the Getting Started section of the manual. To include input routes in the preset, make sure the **input** button at the base of the screen is active. To include trim pot levels and on/off buttons, make sure the **sends** button at the base of the screen is active. The **chs** column of the display indicates the number of channels included in the preset, and presets can be named – by default, Presets are named after input signal 1.

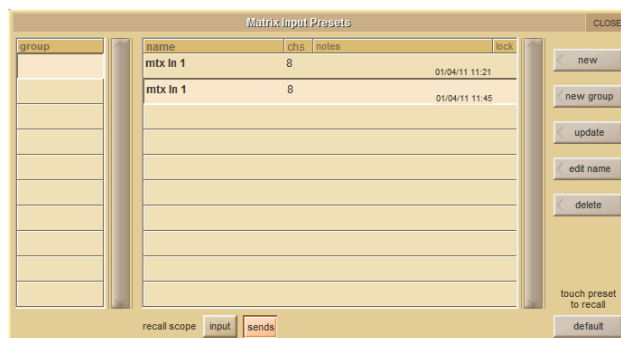

# Chapter 3 - The Master Screen

## 3.7 Graphic EQs Menu

### 3.7.1 Graphic EQ Panel

Touching the **Graphic EQs** menu opens a display of the console's 32-band Graphic EQs for configuration. There are 12 Graphic EQ's which can be assigned to the inserts and outputs of all four channel types, and can also feed the input of an input channel. Graphic EQ routing is done via the channel routing pages, and is not accessible from the master **Graphic EQs** display.

The display consists of miniature representations each EQ, one of which is also shown expanded in the bottom of the display:



The settings on each graphic EQ are accessed via the expanded display, though some settings can also be adjusted in the miniature display. Touch any of the graphic EQs to assign it to the expanded display, or use the scroll bar to the right of the expanded display to scroll through the EQs – the miniature EQ goes lighter blue to indicate that it is expanded. Touch an area of the expanded display to assign the Graphic EQ faders to the 12 worksurface faders on the console – assigned bands have a light brown background.

The EQ currently assigned to the expanded display is indicated in the top left-hand corner of the display, along with indication of the EQ's **source**. The miniature display can be opened and closed by pressing the arrow to the left of the expanded EQ **close** button.

The left-hand side of the expanded display includes metering of the EQ's **IN** and **OUT** signals, a  $\pm 18$ dB gain **trim** pot with value indication to its right, and an **on** button which is ringed red to indicate that it is on. Touch the **trim** pot to assign it to the **Touch-Turn** encoder. The label located beneath each band fader indicates the frequency of the band in Hertz, and the gain associated with each line on the display is indicated to the left of the lowest band. Each band can also be altered within the miniature display.

### 3.7.2 Ganging Graphic EQs

The grey **GANG** and **build gang** buttons above the band faders are used for ganging together different graphic EQ's. When EQs are ganged, their band faders, **on** buttons and trim pots are locked together.

*Note that ganging of faders is relative: EQs can have different shapes when they are ganged, and each EQ will move by the same amount when a band is adjusted.*

*Note that if faders are moved within the miniature display, any other EQs ganged to them will also move.*

To start building a gang, touch one of the graphic EQs to be included in the gang to assign it to the expanded display, and touch **build gang**. The button turns red to indicate that it is active. The **GANG** button to its left will also become coloured, indicating that it is included in the gang being built. To add further EQs to the gang, touch the **GANG** buttons on the other graphic EQs to be included, and they will change colour to match the expanded EQ's **GANG** button. To deselect any EQs from the gang, touch their **GANG** buttons again and they will return to grey. Touch the **build gang** button to complete the ganging process. EQ gang assignments can be adjusted by reselecting the **build gang** button.

*Note - To temporarily isolate a Graphic EQ band from a gang, press and hold the mute button above the band's fader and then make the adjustment to that fader - this move will only be made to that band on the Graphic EQ that you are currently adjusting.*



**3.7.3 Graphic EQ ALL Button .....**

To adjust all EQs at once, select the **all** button to the right of the **build gang** button. It turns red to indicate that it is active. Adjusting any band in the expanded EQ will cause that band in all 12 EQs to jump to that position.

*Note that the all function is absolute: Once a band is altered, any variations on that band between the EQs is eliminated.*

*Note also that the all function does not affect the normal operation of faders in the miniature display.*

To return all 32 bands within one EQ to 0dB, touch the **flat** button to the right of the **all** button, and touch **Yes** in the confirmation pop-up which appears.

*Note that the flat function affects any EQs ganged to the expanded EQ, or all 12 EQs if all is selected..*

Activating the **safe** button, to the right of the **flat** button, protects the graphic EQ settings from being overwritten by a snapshot recall.

**3.7.4 Graphic EQ Presets .....**

Touching the **preset** button, to the right of the **safe** button, opens the **Graphic EQ Presets** display in which current settings can be saved and pre-created settings imported. Preset displays are described in full in the Getting Started chapter of this manual.

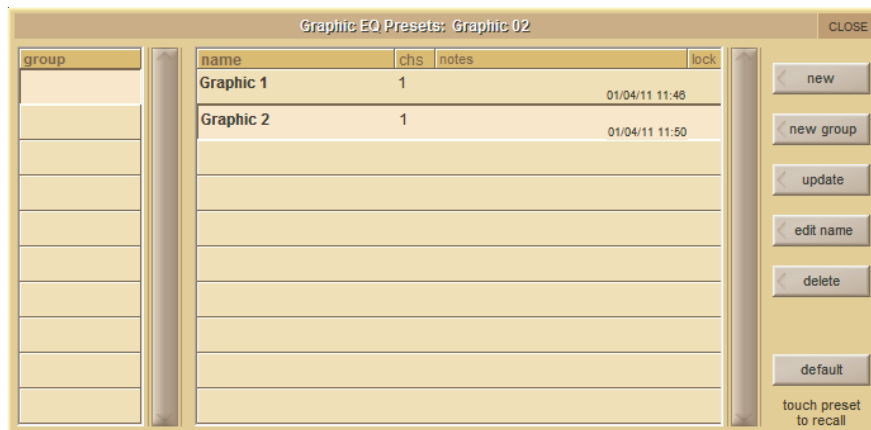

The positions of the **trim** pot, **on** button and all 32 faders are included in an EQ preset. A preset includes only the EQ selected in the expanded view, and its default name will be the EQ from which the preset was taken. Presets can be recalled to any EQ, regardless of which EQ they were created on.

To reset the channel to the default settings, press **default**.

# Chapter 3 - The Master Screen

## 3.8 Solos Menu

### 3.8.1 The Solo Panel .....

Touching the **Solos** menu opens the **Solo 1** and **Solo 2** displays. These displays are used for configuring the console's solo busses. Solo buss 1 is configured in the left-hand display, and solo buss 2 in the right. Both displays function in exactly the same way:

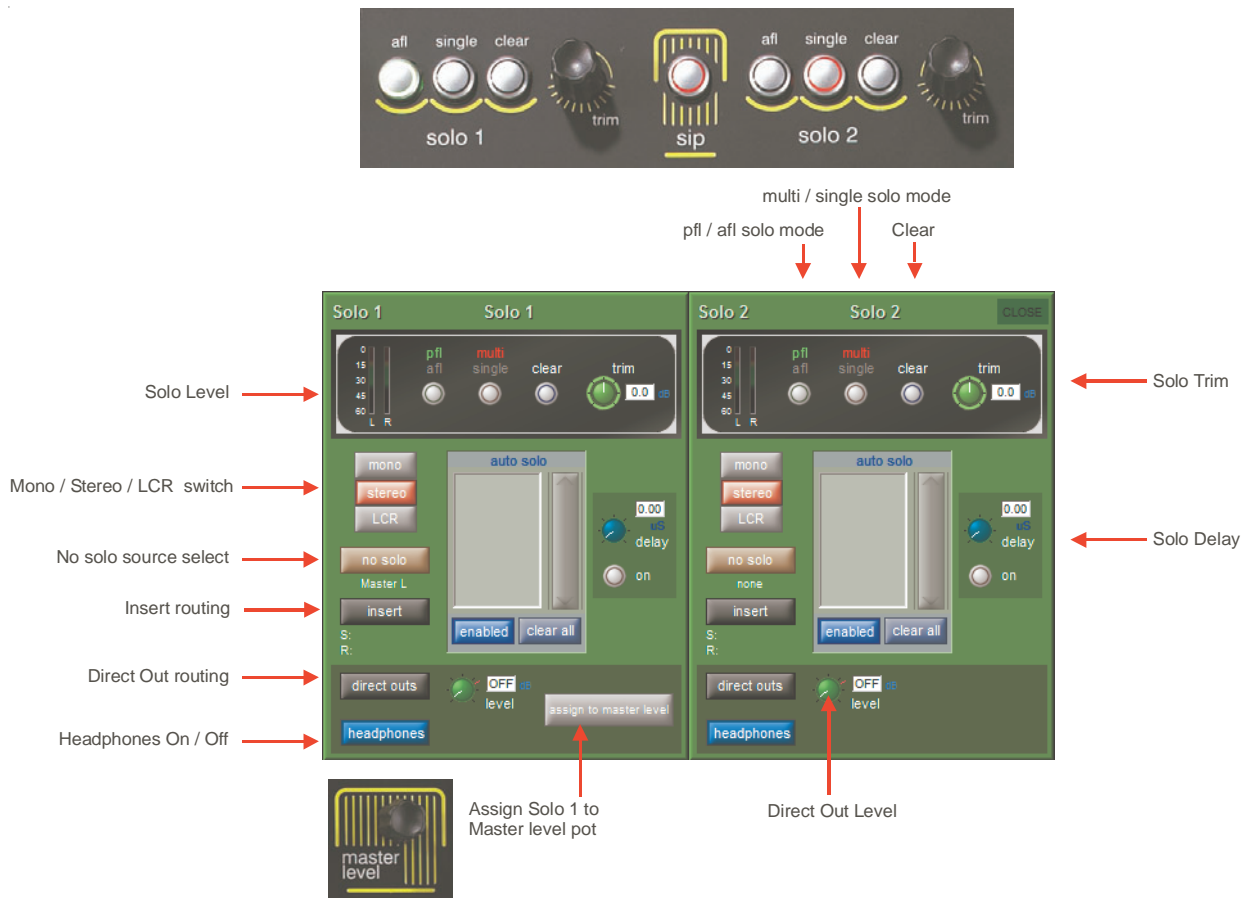

**Note that the in-channel solo functions are described in the Channel Types Chapter**

At the top of each display is a black box containing the solo meter(s), three radio buttons, and an input trim pot. These controls are duplicated on the console worksurface in the right hand section:

The first button selects which point in the channel feeds the buss, and toggles between PFL and AFL, as indicated by the **pfl** or **afl** labelling above the button turning green. The button is also ringed green on the worksurface when **afl** is selected.

The second button toggles the two solo button modes: **multi** in which multiple channels can feed the solo buss at once, or **single** in which only one channel can feed the solo buss. In **single** mode, when a channel is feeding the solo buss, pressing the solo button on a different channel will cause the originally selected channel to be deselected from the solo buss. The solo button mode is indicated by the **multi** or **single** labelling above the button turning red. The button is also ringed red on the worksurface when **single** is selected.

All feeds to the solo buss can also be cleared by pressing the **clear** button. When there is a feed to that solo buss somewhere on the console, the button is ringed blue on the worksurface.

The level of the solo buss can be adjusted using the on-screen **trim** pot or the trim encoder on the worksurface. The on-screen **trim** pot is always assigned to this worksurface encoder, as indicated by the presence of green ring around it. The signal can be trimmed by  $\pm 18$ dB, and the trim value is indicated to the right of the on-screen **trim** pot.

In the centre of the **Solo 1** or **Solo 2** display, there is an **auto solo** area which lists all the channels which are selected for the **auto solo** function. This function automatically routes selected channels to that solo bus whenever another channel is assigned to it, and the

selected channels can be scrolled if necessary using the scroll bar on the right of the list. The **auto solo** channels are selected in the Channel Setup display. This **auto solo** function is enabled and disabled by touching the left-hand blue button below the **auto solo** list. The button label displays whether the **auto solo** function is **enabled** or **disabled**. The channels in the **auto solo** list can all be removed by touching the clear all button below the **auto solo** list.

**Tip: If you are using effects returns, selecting auto solo will allow soloed tracks to be auditioned with their effects returns.**

The solo buss signal can be delayed using the **delay** pot to the right of the **auto solo** area. Switch the delay on using the **on** button below the pot. Touch the pot to assign it to the Touch-Turn encoder. The delay value has a range of 0 to 2.7 seconds and is displayed above and to the right of the **delay** pot.

The **mono** and **stereo** buttons to the left of the **auto solo** area select whether the buss is mono or stereo. Each button is red when selected and grey when not selected. The selected format is also indicated by the number of meters displayed in the top-left corner of each display.

### 3.8.2 The No Solo Setup Display .....

Below the **mono** and **stereo** buttons is a button marked **no solo**. This button defines what signal (if any) is present on the buss when no channel solo is active. By default, there is no signal feeding the buss when no channel solo is active. Pressing this button opens the **No Solo Setup** display:



At the top of the display, there is a text box which can be used for renaming the solo buss. Touch the box or the keyboard symbol to its right, type the new name on the on-screen or external keyboard and press **OK**. The **Channel Name** display containing commonly used words for quick insertion can be accessed for buss naming by touching the down arrow immediately to the right of the text box. The solo buss name will then appear at the top of its master solo display, and in any solo-assigned master faders (See below for details).

Below the naming area, there are two columns of buttons used for selecting the audio source for the **no solo** function from among the group and aux channels. The left-hand column contains two pairs of buttons: the **groups** buttons (**mono** or **stereo**) and the **auxes** buttons (**mono** or **stereo**). Touching one of these buttons causes it to lighten to indicate that it is selected, and results in a list of those channels appearing in the right-hand column. A scroll bar appears in the right of the display if the channel list is too long for the window. Touching one of these signal buttons assigns it to the **no solo** function, as indicated by the lightening of the signal's button and by the labelling immediately beneath the **no solo** button displaying the signal name. If a stereo signal is selected here, only the left-hand signal is displayed beneath the button. Signals can be deselected by touching them again. When no signal is selected for the **no solo** function, the labelling beneath the button displays **none**.

To close the **No Solo Setup** display, press the **CLOSE** button in the top right-hand corner.

The area below the **auto solo** area concerns the solo buss outputs. In the centre of the output area, there is an output level pot. Touch the pot to assign it to the Touch-Turn encoder. The buss output level trim ranges from **OFF** to +10dB, as indicated to the right of the pot.

## Chapter 3 - The Master Screen

### 3.8.3 Assigning Solo Busses to Worksurface Controls .....

The solo buss 1 output level is permanently assigned to a worksurface control and solo buss 2 level can also be assigned to a control labelled Master level / Solo Level 2. This is done by pressing the on screen **Assign To Master Level** button and the LED next to the worksurface control will go green when it is active. Normally this control is assigned to the Master buss level and the LED would show red.

### 3.8.4 Solo Outputs Routing .....

Each solo buss includes an insert send and return, and a direct output, both of which are routed in the **Solo Outputs** display. This display is accessed by touching the **insert** button below the **no solo** button, or the **direct outs** button in the top left of the solo buss output area.

*Note that the insert point only applies to the Solo buss Direct Output, not to the headphone signal.*

At the top of the **Solo Outputs** display, the buss naming function described above is duplicated. Towards the bottom of the display, there are two buttons marked **output** and **insert A**. Selecting one of these buttons assigns that send (or send and return) to the signal routing area above it: When the insert is assigned, the **ins A send** routing button appears in the left-hand column, and the **ins A return** routing button in the right-hand column; When the output is assigned, the **outputs** routing button appears in the left-hand column and the right-hand column is left blank. Pressing any of these routing buttons opens a routing display. Insert and output routing can then be routed as described in the Getting Started section of this manual.

An extra button labelled **send+return** is included above the **ports** list in the **Insert Send Route** display button. When this button is activated, the send and return routing is linked for all signals within the **INTERNAL** port: If the **Graphic 1** input is assigned to the insert send, the **Graphic 1** output is automatically assigned to that insert return. Similarly, if it is the return which is manually assigned, the send automatically copies that send assignment. The **send+return** button is grey when inactive and brown when active.

Once the insert send and return signals have been selected, level trim pots appear in the bottom half of the **Solo Outputs** display. To the left of both pots there is a meter (or pair of meters, in the case of stereo channels) displaying the send or return level, and to the right of both pots there is a numeric display of the level trim in dB. Below the send level trim there is an **on** button which switches the send on and off. Below the return level trim there is a reverse phase button which inverts the phase of the returning signal. Both of these buttons become ringed in red to indicate that they are on.

Once any insert or direct out has been routed, the route is displayed below the button in the **Solo 1** or **Solo 2** display.

*Note that the mono>mono and mono>stereo buttons define the configuration of mono buss routing to stereo FX units, as described in the Getting Started chapter.*

### 3.8.5 Headphone Outputs .....

Touching the **headphone** button in the bottom left-hand corner of the display sends the solo buss signal to the headphone sockets, located to the left of the console faders and under the arm rest. The button turns blue to indicate that it is active.

The headphone output receives both solo buss signals, and the headphones will be silent when neither buss is routed to them, unless a **no solo** signal has been assigned.

The headphone level is controlled by the output **level** pot in the output area, and also by the headphone level encoder located in the left hand section of the worksurface. The headphone signal can be muted by pressing the **mute** button next to the worksurface headphone level encoder, and the button is ringed red to indicate that the headphone send is muted.



### 3.9 Setup Menu

#### 3.9.1 Audio I/O .....

The **Audio I/O** display is used to configure the physical I/O connected to the SD11, including identifying and naming the sockets of the option cards installed in racks, and the setting of pads and phantom power.

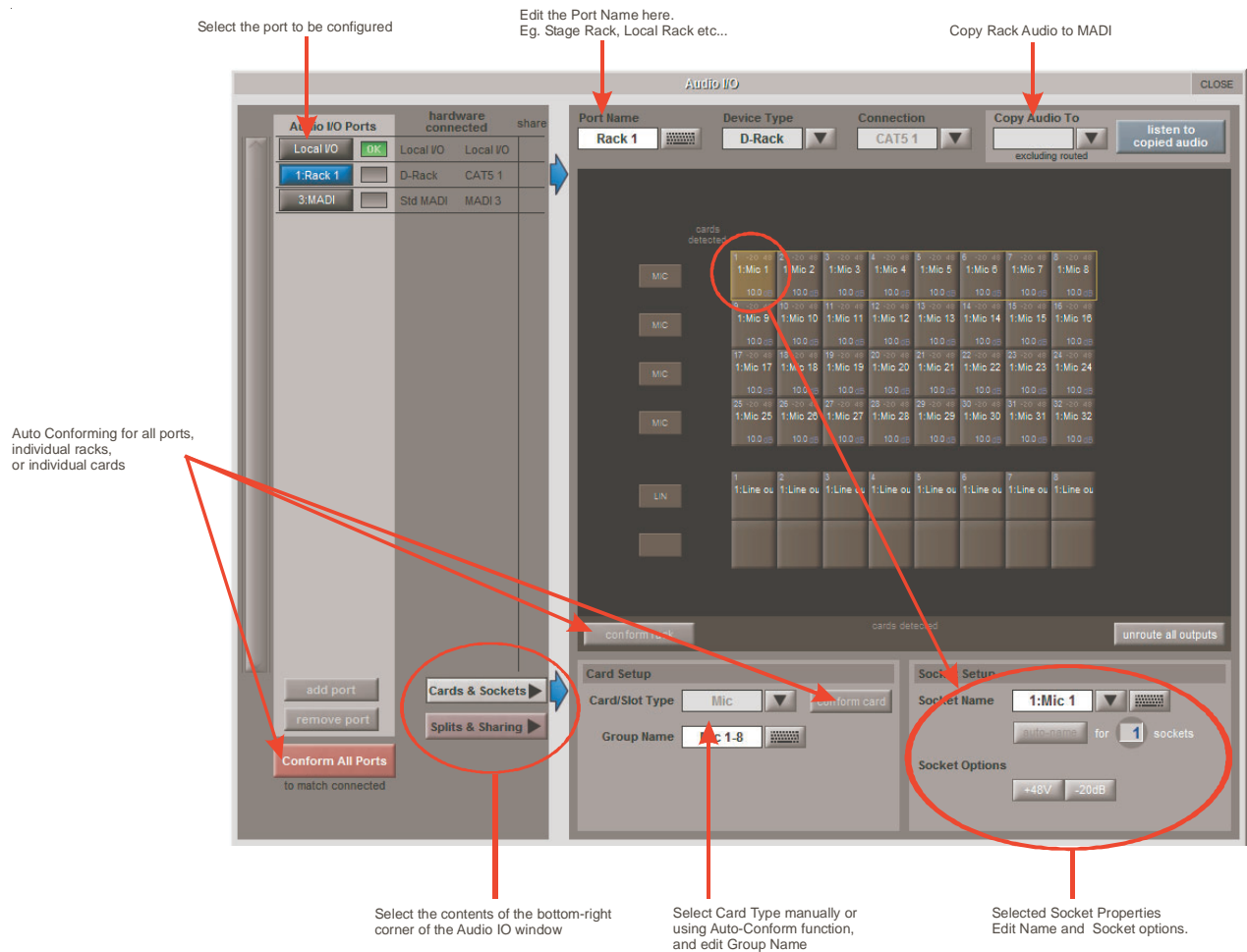

#### 3.9.2 Port Selection .....

The **ports** buttons in the top left-hand corner of the display select which port is being configured in the rest of the display. Each port relates to a set of physical audio connections:

- Local I/O**      The Input/Output sockets on the rear of the console
- Rack**            A remote I/O rack connected via CAT5e
- MADI**            A remote I/O rack connected via MADI

Once a port has been selected, the connections contained within it are displayed in the Sockets graphic which makes up the most of the rest of the **Audio I/O** display.

The box to the right of each port selection button displays the current state of the connection/

#### **Copying Audio and Listening to Copied Audio (MADI Recorder Setup)**

Incoming audio from the D-Rack(s) can be copied to the MADI Output by selecting the incoming Port in the Ports list and using the **Copy Audio To** drop down menu. For example, if you want to copy Rack 1's audio inputs to a MADI equipped recorder connected on the MADI Port, select **Port 1** in the ports list and then select **MADI** from the **Copy Audio To** drop down menu. The console will send the 32 channels of audio from Rack 1 to the MADI Output and it can be recorded as necessary.

In addition, by connecting the recorder's MADI Output to the console's MADI Input, the playback can be monitored in the same channels as the original source material. Just press the **Listen To Copied Audio** button to monitor playback and press it again to return to monitoring the live sources from the rack.

# Chapter 3 - The Master Screen

## 3.9.3 Port Hardware Configuration .....

The port is named automatically according to its connection type, as displayed to the right of the **ports** selection area. However, the name can be edited by touching the **Port Name** box or the keyboard symbol to its right, typing the new name into the QWERTY keyboard which appears, and pressing **OK**. The type of device connected to the port can be altered by touching the down arrow next to the **Device Type** box, located to the right of the **Port Name** box, and selecting the appropriate device from the drop-down list that appears.

*Note: Port 1 can only be connected to any DiGiCo rack, with the addition of a Little Red Box or a Little Blue Box (contact DiGiCo for details), but the MADl port can be any type of DiGiCo Rack or a Standard MADl connection.*

*Note: the configuration of the Local I/O port is fixed, so no hardware changes are possible. You can, however, change the Port Name, the Group Names (relating to name of each physical card) and the Socket Names (the name of each physical connector on a card).*

## 3.9.4 Port Control .....

Normally, the input gain, phantom power and pad of each Rack input is controlled remotely by the SD11. However, in multi-console systems where DiGiCo racks are being shared between two DiGiCo consoles, only one of the consoles can remotely control these rack settings. The level of control assigned to the current console must therefore be defined. Control options are displayed in the bottom-right area of the **Audio I/O** panel when the **Splits & Sharing** button towards the base of the panel is pressed:

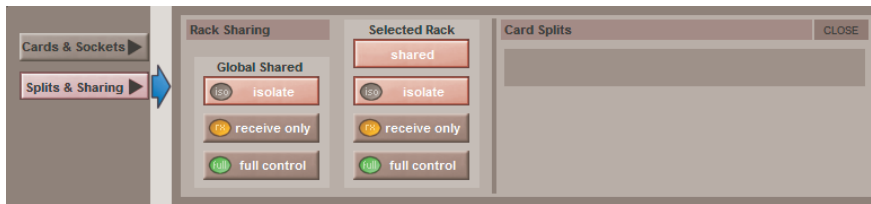

There are three levels of control:

- isolate:** The SD11 will not exchange any control data with the rack. This means that the console will neither be able to adjust rack settings, nor adjust its own settings according to returning control data.
- receive only:** The SD11 will receive the rack's existing settings but not send control data back. This means that the console will not be able to adjust rack settings, but will be able to adjust its own settings according to returning control data.
- full control:** The SD11 will receive the rack's existing settings and will send control data back. This means that the console will be able to adjust both its own settings and the rack's settings.

When the **Rack** port is selected in the main panel, its control can be defined as shared by pressing the **Shared** button. Either set of **isolate**, **receive only** and **full control** buttons can then be used to define the level of control.

## 3.9.5 The Socket Display .....

When a port has been selected from the **ports** list on the left, the individual connections within that port are displayed in the Sockets graphic, which makes up most of the rest of the **Audio IO** display. For Rack ports, each column or row (depending on the rack type) in the graphic represents an IO card, and the type of IO card is displayed at the bottom or left side of each column or row. For the **Local I/O and D-Rack** ports, each row represents a type of I/O socket.

Each individual socket displays the following information: the current socket name is across the middle, and the socket number within the card is in the top left-hand corner.

For standard rack analogue input sockets, the current gain is at the bottom, and the top right-hand corner displays a red **48** symbol if the socket's phantom power is switched on.

For Local I/O and D-Rack analogue input sockets, the current gain is at the bottom, and the top right-hand corner displays a red **48** symbol if the socket's phantom power is switched on. Next to the 48 indicator is a **-20** indicator to show whether the socket's -20dB pad is active.

For standard rack analogue rack output sockets, there is a **-10** symbol in the top right-hand corner which is yellow to indicate that the 10dB pad is switched in, and white to indicate that no pad is present.

*Note: There is no -10dB pad available for Local I/O and D-Rack outputs*

For digital inputs on the Local I/O the status of Sample Rate Conversion On/Off is displayed.

Touching a socket within the graphic assigns that socket and its card to the area below the graphic for configuration, as described below.

## 3.9.6 Socket Conforming .....

In order to use the rack, the on-screen contents of the rack must match the cards physically installed in the rack connected. There are two ways of achieving this:

### Manual Conforming

Select each card (column) and manually select the appropriate card in the **Card/Slot Type** drop down menu in the lower section of the window. Once the correct card type is selected, the card type name at the bottom the selected card will turn green, indicating the card type matches the card installed in the rack. If there is a mismatch, the card type name will be red, and the error should be corrected by selecting the correct card type.

### Automatic Conforming

The audio I/O can be automatically conformed for the whole console (using the **Conform All Ports** button in the bottom left of the panel) or the currently selected rack (using the **conform rack** button below the socket display). Pressing these buttons will correctly select the correct card for each slot. Once complete, all of the card labels beneath each slot should turn green.

It is also possible to auto-conform on a card-by-card basis: With a single card selected (by touching any of the sockets on that card), press the **Cards & Sockets** button towards the base of the screen, followed by the **conform card** button which appears in the area to its right.

## 3.9.7 Group and Socket Names .....

Cards and sockets are named automatically, according to the **Device Type**, **Card/Slot Type** and their position within the port. To edit these names, press the **Cards & Sockets** button towards the base of the **Audio I/O** panel to bring up the **Card Setup** and **Socket Setup** displays to its right:



Touch either the **Group Name** or the **Socket Name** box (or the keyboard symbols to their right), type the new name into the QWERTY keyboard which appears and press **OK**. Touching the down arrow in between the **Socket Name** box and keyboard symbol opens up the **Channel Name** display which enables commonly used words to be inserted quickly without the use of the keyboard.

A range of sockets can be named with the same label and an incrementing number by using the **auto-name** function below the **Socket Name** box: To define how many sockets will be auto-named, touch the numeric display, turn the **Touch-Turn** encoder to the right of the screen until the numeric display below the keyboard symbol displays the correct number. Alternatively, touch the numeric display, type in the number of sockets to auto-name into the keypad that appears, and press **OK**. Once the number of sockets has been defined, the auto-name button becomes active. Pressing it will cause the name of the assigned socket to be replicated for all the sockets selected for auto-naming. If the assigned socket's name does not end in a number, a '1' will be added to it and incremented for the remaining sockets. If the assigned socket's name already ends in a number, that number will be incremented for the remaining sockets.

## 3.9.8 Socket Options .....

Depending on the socket type, further **Socket Options** may be displayed below the **Socket Name** area.



# Chapter 3 - The Master Screen

## 3.9.9 Audio Sync .....

Selecting **Audio Sync** from the **Setup** menu opens the **Audio Sync** display. This is where the clock master is selected. The SD11 will operate at a sample rate of 48000Hz (48kHz), as indicated in the **SAMPLERATE** box at the top of the display:

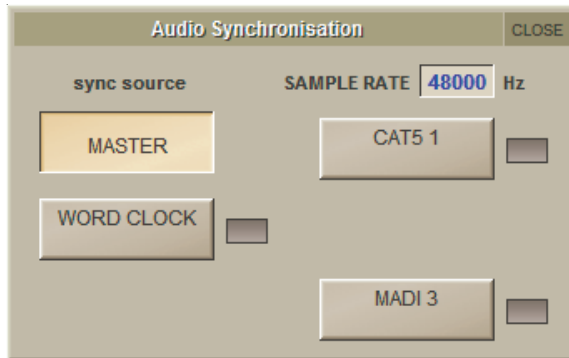

Within a normal setup, the SD11 will usually be the clock master, indicated by the **MASTER** button on the left of the display being selected. However, there are times when the SD11 needs to be clocked externally. The sources from which an external clock can be taken are shown in the rest of display: **Word Clock**, the **CAT 5** input or the **MADI** input. When a valid clock is detected on an external sync input, it will have a green **OK** symbol to its right, even if that input is not selected as the clock source for the SD11. To select an external source, simply touch the appropriate labelled box from among those which have a green **OK** symbol.

## 3.9.10 Timecode & Transport .....

This section of the **SD11** has not yet been implemented.

## 3.9.11 Macros .....

Selecting **Macros** from the **Setup** menu opens the **Macros** display:



This is where macro commands can be assigned to the 8 buttons in the **macros** area located in the left hand section of the console (shown below), as well as to the function (F) buttons on the external keyboard and to the console's GPs. Macros can also be fired directly from this list by touching the macro when none of the right-hand buttons is active.



The **Macros** display includes a list of all the macro commands which have been created, along with the button to which they have been assigned, if this has been selected. The list is scrollable using the scroll bar to the right of the list.

**Note that this list therefore includes macros which have been created but have no trigger.**

To create a blank macro, touch the **new** button, in the top right-hand corner of the display. To create a macro based one that already exists, touch the **duplicate** button below the **new** button, followed by the macro you wish to duplicate. When either button is touched, a macro is created with the default name **macro n** where n is an auto-incrementing number, and the **Macro Editor** display (described below) is opened. A duplicate macro will contain all of the settings of its parent, apart from the name.

To edit a macro, touch the **editor** button below the **duplicate** button, followed by the macro you wish to edit. The **Macro Editor** display (described below) will then open.

Macros can be assigned from the main **Macros** display without opening the **Macro Editor** by touching the **assign** button below the **editor** button, touching the macro you wish to assign, and then pressing the button to which you wish to assign the macro.

Macros can be deleted by touching **delete**. To delete all the macros in the list, touch **select all**, followed by **confirm**. To delete one macro or a selection of macros, touch the macros you wish to delete followed by **confirm**. To delete a consecutive range of macros, touch **select range**, touch the first and last macros included in the range to be deleted, and touch **confirm**.

### 3.9.12 The Macro Editor .....

The **Macro Editor** is where macros are defined, including the commands included in the them and the button used to trigger them. Virtually any command within the console can be assigned to a macro, ranging from opening panels to adjusting in-channel signal processing.

**Note that fx parameters are only included available once fx units are in use in the session.**

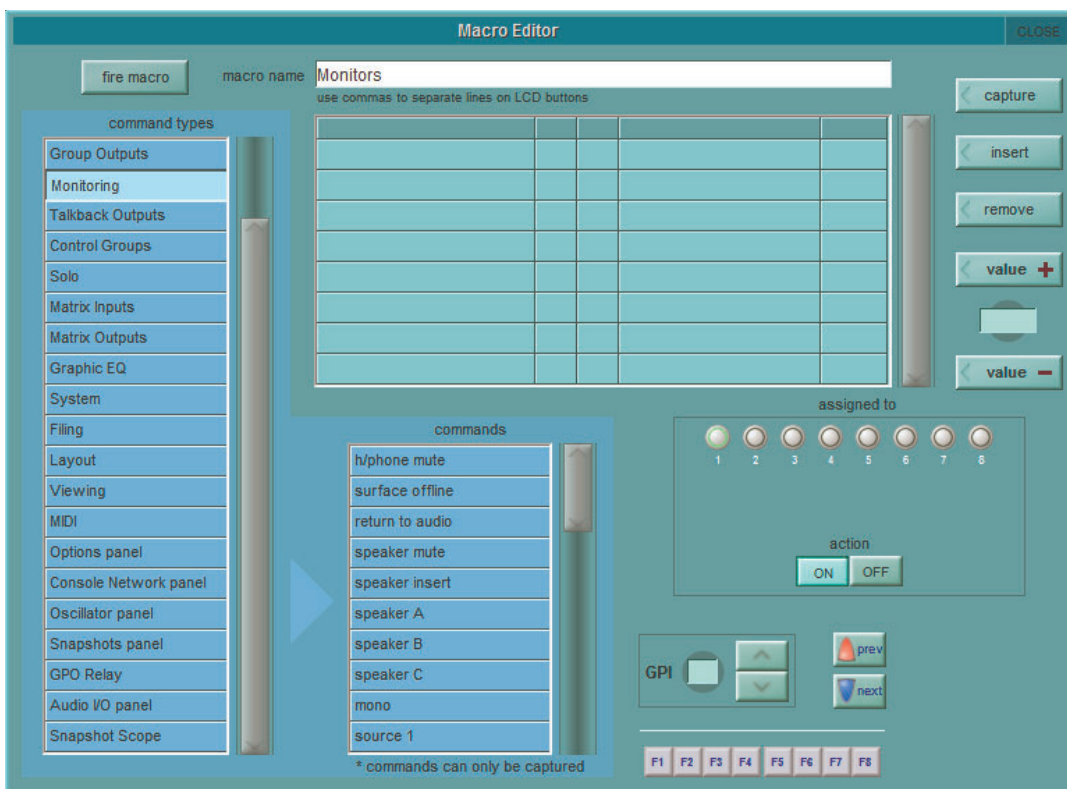

The name of the macro being edited is shown at the top of the display. To switch to a different macro in the list, touch the new macro in the Macro display list (You may need to move the displays around the panel to access the list). To rename the macro, touch the **macro name** text box, type the new name in the on-screen or external keyboard, and touch **OK** - This name will be used in the Macros display.

The list beneath the **macro name** text box, lists the commands currently included in the macro. When there are multiple commands in the included commands list, they are triggered in the order in which they are listed. New commands are added to the selected row in the list, overwriting any command previously in that row. To insert a row for a new command in between two adjacent commands, touch the row above which you want to insert the command, then touch the **insert** button to the right of the included commands list.

## Chapter 3 - The Master Screen

---

There are two ways of adding a command to the included commands list:

1. Touch the row in the list in which you want the command to appear, then touch the **capture** button, located in the top right-hand corner of the display. The button turns pink to indicate that it is active. Any commands now actioned on the console will then be added to the included commands list. Once all the desired commands have been actioned, deselect the **capture** button.
2. Touch the row in the list in which you want the command to appear, then touch one of the command types in the scrollable **command types** list to the left of the display. This brings up a list of the commands within that command type in the scrollable **commands** list in the centre of the lower half of the display. Touch the desired command to bring it into the included commands list.

For commands associated with worksurface controls (all command types above **System** in the **command types** list), the included commands list displays the command type (in the **channel type** column), the scope of channels included in the command where appropriate (in the **from** and **to** columns), the command's name (**controller**) and any value associated with the command. For command types associated with the master panel (from **System** down), the included commands list displays the **command**, along with any **filename** or **value** associated with it. The list can be scrolled if necessary using the scroll bar to its right.

The values in the **from**, **to** and **value** columns can be adjusted by using the Touch-Turn encoder and **value +** and **value -** buttons to the right of the included commands list. Touch the box to be adjusted to assign it to the encoder and value buttons. The present value is shown in the display in between the value buttons. If the **value** column displays something other than numeric values, the options are cycled using the Touch-Turn encoder and **value +** and **value -** buttons (cycling for example, between **on**, **off** and **toggle**). Values can also be typed in by touching the value box, typing the new value using the external or on-screen keyboard, and touching **OK**.

To remove a command from the list, touch the command to be removed and touch the **remove** button to the right of the included commands list.

The bottom-right of the **Macro Editor** is used to define what triggers the macro. The **action** buttons define whether the Macro is to be triggered by a macro button **ON** command or a macro button **OFF** command. This means that one macro button can trigger 2 different macros depending on whether it is switched **ON** or **OFF**. If you do not require the macro button to trigger 2 different macros then set the action to **ON**. Selecting a new trigger for a macro automatically deselects any old trigger that might have been assigned.

Macro buttons are selected by touching one of the eight buttons below the **assigned to** legend (causing the button's ring to light green, indicating that it is selected).

GPIs are selected by touching the **GPI** number box and using the **Touch-Turn** encoder, or by using the arrow buttons to the right of the **GPI** number.

Function keys on the external keyboard are assigned by touching the **F1** to **F8** buttons at the bottom of the display.

Macros can be tested by touching the **fire macro** button, located in the top left-hand corner of the display. Once the macro has been fully configured, close the **Macro Editor** display.

## 3.9.13 Talkback .....

The talkback area of the console is located in the top right-hand corner of the right hand section. The talkback area includes a **gain** control encoder and a **talk** button. Pressing the **talk** button routes the talkback mic to the talk buss output, as assigned in the **Talkback** display. The button is momentary if held, and latching if pressed quickly. The **talk** button only functions if there is a valid output route for it.



The **Talkback** display is opened by selecting **Talkback** from the **Setup** menu. This is where the talkback routing is configured.



In the right-hand side of the **Talkback** display, there is a mic **input** gain pot which is always assigned to the **gain** encoder in the worksurface talkback area. The pot's gain value is indicated in dB in the box above the pot. The talkback signal level is shown in the meter to its right. Touching the white box below the gain pot opens up the **Talkback Input** display which consists of an **input route** button. The current route is displayed below the button. Pressing the button opens up the **TB Input Route** display, which functions in the same way as all other input routing panels.

To the left of the input section of the display, there is a Talk button, with a text box beneath it. Touching this button enables and disables the talkback button on the worksurface. The button rings red to indicate that the buss is active. Touching the text box beneath the button opens the **TB Outputs** display for the talk bus. This consists of a naming area and an **outputs** button. The first output currently selected is displayed below the button.

Pressing the button opens up the **TB Output Routes** display which functions in the normal way. The first selected route appears in the text box below the talk button.

**Note that the talk buss can be routed to more than one output.**

## Chapter 3 - The Master Screen

### 3.9.14 Talk To Auxes .....

In order to talk to individual or multiple of Aux outputs there is an assignable row of controls on Aux Outputs, controllable independently or from the Talkback panel which has a Talk to Aux select list for the Talk button. This is implemented as a Talkback Input channel which uses a single engine processing channel to provide the aux sends. This channel appears, in a default session, on its own in the last bank on the left of the console.



On the Aux Output channels, press **Aux** in the **Quick Select** buttons and the row of assignable controls beneath the screen can be used to switch Talk to Aux On/Off, control the level of talkback signal and set the level of dim when the talk is active. This **dim** level setting is a 2nd Function so press the 2nd Function button and use the under screen control to adjust it.

The worksurface **talk** button can also be programmed to activate the Talk function on single or multiple user defined channels. Open the **Setup/Talkback** panel and touch the label above the **talk** button, then select any combination of Mono and Stereo Auxes to activate with that button.

# **SD11 Operation Manual**

## **Chapter 4:**

### **Network & Mirroring**

# Chapter 4 - Network & Mirroring

## 4.1 Network and Mirroring

### 4.1.1 Network Configuration .....

The SD11 console is fitted with a network card and offers the possibility of remote controlling the console from a standard PC. In order to take advantage of this, you need to verify the console networking is functioning and synchronise your session between the two devices.

The SD11 software on the PC is exactly the same as the console software and the USB key that is provided with the console will contain a file called SD11\_0xx.exe that should be used to install the software on the PC.

Alternatively download the Offline Software from the Support downloads section at [www.digico.biz](http://www.digico.biz).

Run this self extracting ZIP file and change the install path from D:\SD11 to C:\SD11 - this will copy the SD11 folder and its contents to C:\SD11. Now create a new folder called C:\Projects which is where you will save and load your sessions from.

Finally, open the C:\SD11 folder on your PC and double click on the SD11.exe program file to run the application.

**IMPORTANT NOTE - When mirroring a console to a PC you are required to set a static IP address on your PC which is in the same subnet as the console itself. The console's subnet mask is 255.255.0.0 and its IP address can be seen next to its entry in the Network panel - in the picture below it is 192.168.1.100.**

**The IP address of the PC must start with 192.168.xxx.xxx. and must be different to that of the console.**

**The setup of network addresses on a PC may differ from one operating system to another so if you are in doubt, please consult the documentation for your PC's operating system before proceeding.**

As an example, on Windows XP, the IP address and subnet mask can be changed by:

- 1) Opening the **Control Panel>Network Connections**.
- 2) Right clicking on the **Local Area Connection** and selecting **Properties**.
- 3) Double Click on **Internet Protocol (TCP/IP)** from the list to show its **Properties**.
- 4) Set the radio button to **Use the following IP address**
- 5) Type the **IP Address** and **Subnet Mask** as detailed above
- 6) Confirm the changes and restart the computer

Before the console and PC can be mirrored, you should ensure that a standard crossover network (Ethernet) cable is connected between the two devices. Without this connection, the two devices will not "talk" to each other.

To open the Network window, touch the **Network** button at the top of the Master Screen. The following window will open...

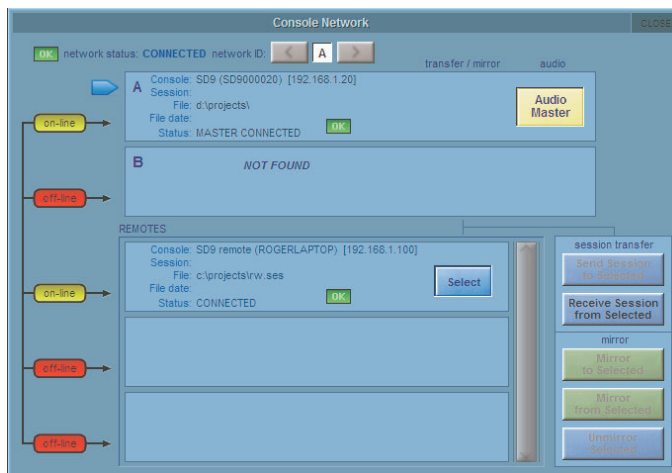

When running SD11 software on a PC the software will appear in a number of "floating" windows, each of which represent a console section. A screen touch on the console is simulated by a right click with the PC mouse. To switch between console sections use the small toolbar buttons that also appear on the screen marked Master\Channels\Overview.

### 4.1.2 Mirroring for the first time .....

If the console and the PC are connected together, but do not see each other you will see red offline indicators next to the device entries in the network list. In this case you may need to enable Networking.

There is an option in the **OPTIONS/SESSION** tab to **ENABLE CONSOLE NETWORK (YES/NO)**. This must be set to YES on both devices. After doing this, shutdown and restart both devices and when the sessions are loaded go to the NETWORK window and you should see yellow Online lights against Engine A and one of the Remote Control slots as in the picture above. This indicates that the network has connected the two devices but they are not yet mirrored.

In order to mirror the two devices, they need to be running the same session. The way to achieve this is to load the session into the console, then transfer it to the remote PC using this Network window.

1. Load your session into the console.
2. Open the Network Window
3. Press the **Select** button for the Remote PC and then press the **Send Session To Selected** button.



This will copy your current console session and load it into the remote PC. Once this is done, the remote detail section will change to reflect the new loaded session. You can also check that this process is complete by looking at the remote PC and waiting for the progress bar to indicate that the session has finished building.

You can now press the **Mirror To Selected** button or the **Mirror From Selected** button.

**Note: We recommend mirroring the console TO the remote PC to ensure that the current state of the console is transferred to the remote PC.**

The Mirror buttons will turn green, and the console is now mirrored.

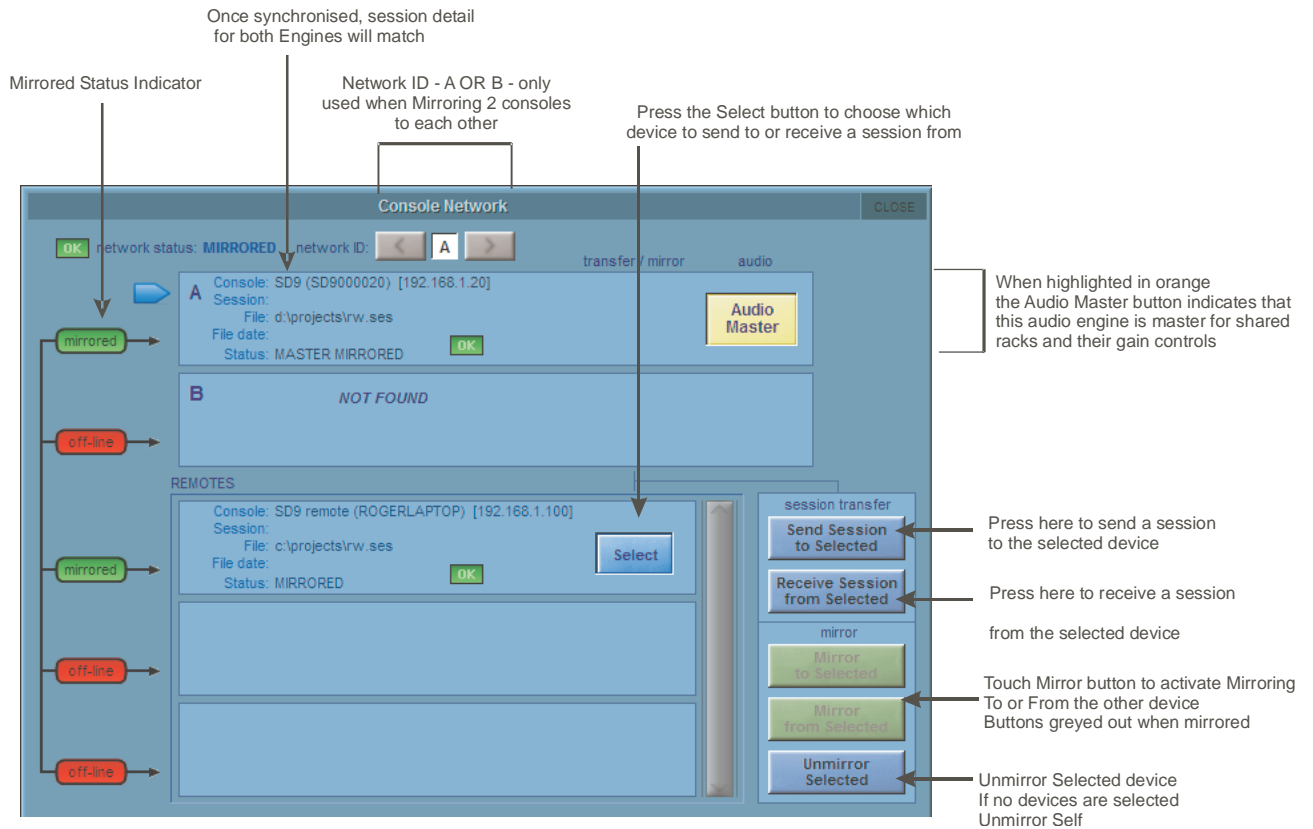

**Note - The exact method of Mirroring is determined by a setting in the Options panel / Sessions tab - see below**

## Mirroring Mode

This option determines how the console will behave when Mirrored via a network to another console or Offline PC.

This option is saved for console not in the individual session.

There are 4 modes of operation.

Full Mirror - all functions mirrored from one device to the other.

Expander - intended for use with an SD7 console and an EX007 Expander unit. The second device mirrors most functions from the first device but significantly, allows different banks to be selected on the different devices.

Remote - intended for use with a PC being used as a Remote Control for a console. Allows different banks to be selected and different setup options on each device.

One Way - only to be used in exceptional circumstances when specifically directed to do so by a qualified DiGiCo support representative.

Functions are mirrored from one device to the second device but not from the second device back to the first.

4.2 Multi-console Setups

4.2.1 FOH and Monitors sharing a stage rack .....

It is possible for 2 DiGiCo consoles to share the inputs from a remote DiGiCo Rack by using the 2 sets of MADI ports on the rack. In the case of the SD11 the shared rack must be connected by BNC MADI cables to console Port 3. In this situation, only one of the consoles can control the rack functions such as the analogue gain of the mic pre amp and the phantom power switching.

The suggested setup for two SD11's which are sharing the same rack is as follows:

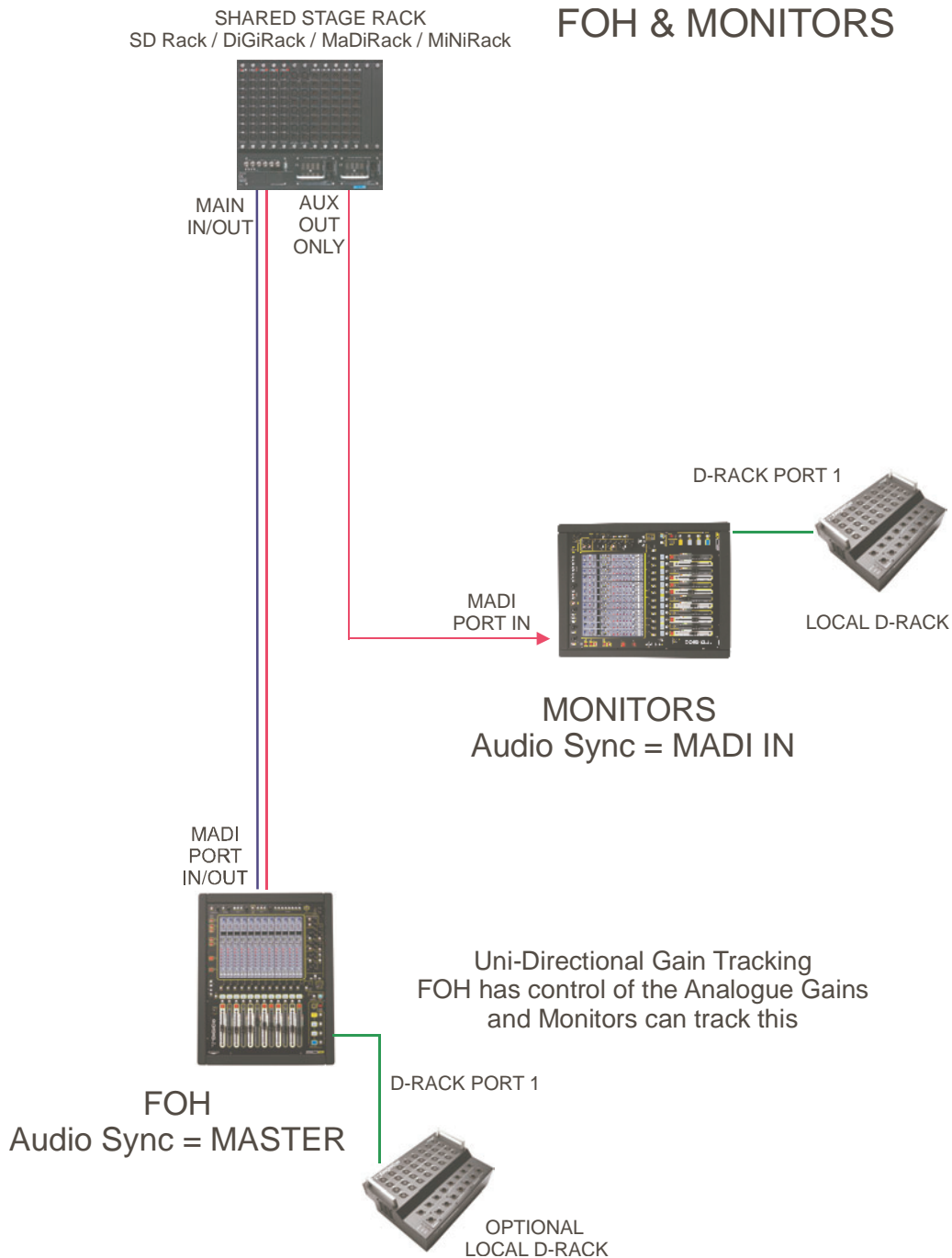

The recommended connection between the Monitor console and Stage Rack is a single MADI OUT from the Stage Rack's AUX MADI connected to the console's MADI IN.

The FOH (Master console) is connected via MADI IN and OUT to the stage rack.

A similar method can be used if the Monitor console requires gain control and the FOH console will track the gain changes.

MADI OUT from the Stage Rack's AUX MADI connected to the FOH console's MADI IN..

The Monitor (Master console) is connected via MADI IN and OUT to the stage rack.

Each console may also optionally be connected a D-Rack for its own local signals.

**Note - The console that is controlling the gains should be set to Setup / Audio Sync = Master and the console that is tracking should be set to Setup / Audio Sync = MADI**

- 1) Open the **Setup>Audio I/O** panel, select the shared rack port from the port's list (eg MADI Port) and then press the **Shared** button for that rack. Do this on both consoles and the rack control functions **Isolate/Receive Only/Full Control** will become available.
- 2) One console should be fully connected to the racks using the **Setup>Audio I/O** panel's **Full Control** button for the **Shared** racks. This console's **Network / Audio Master** button should be pressed (Orange) to allow Full Control to be set.
- 3) The operators should agree on and set a level of analogue gain that provides enough headroom for the required application.
- 4) The second console should connect to the Shared racks in **Receive Only** mode. This console's **Network / Audio Master** button should be off (Grey) to allow Receive Only to be set.
- 5) Gain Tracking (the **Track** buttons at the top of the Input channel screen) should be switched on for the console that is in **Receive Only** mode for all the channels that are being shared.
- 6) When an analogue gain control is changed on the "Master" console, the "Slave" console's analogue gain should reflect the changes and the digital trim control should compensate for this change by moving by the same amount in the opposite direction.

# **SD11 Operation Manual**

## **Chapter 5:**

## **Troubleshooting**

# Chapter 5 - Troubleshooting

---

## 5.1 Troubleshooting

### 5.1.1 Starting the console .....

If, for any reason, you have a problem starting the console, turn the power supplies off and on again and as the console starts up, hold the keyboard **SHIFT** key. This will enable you to select the **Revert To Defaults** option that will appear on the screen and the console will start up with an empty session, ignoring any previous startup or automatic recovery sessions.

### 5.1.2 Audio not passing on certain channels .....

There are many things in the audio processing path that could prevent a signal from passing from its input to an output or the monitoring system - here are some things to check if this situation occurs:

**The input channel is set to use its ALT Input** - look for a small red button at the top of the on screen channel marked **ALT IN** - in this case, assign the channel by touching the screen, touch the top of the channel to open the Channel Setup panel and press the MAIN input button at the top of panel.

**Inserts In on Input channel** - either channel insert A or B is active but has no Send & Return route.

**Channel or Group fader down** - check that all faders in the path of the signal are up

**No Output Routing** - touch the bottom of the input channel screen to open the output view and ensure that the channel is routed to the correct buss or Direct output

**Inserts in on Group channel** - the buss that the channel is routed to has insert A or B active but has no Send & Return route

**Something is soloed** - a solo is active on one of the console channels - press Solo Clear on the right hand worksurface

**Hard or Soft Mute on Input Channel or Group** - a mute is active on either the input or output channel in question - hard mute is accessed by pressing the 2nd Function button and using the normal channel mute button.

**Control Group fader down or muted** - the channel in question is the member of a Control Group that is muted or turned down.

**Gate In Input Channel or Group** - the input or output channel has an active gate that is not opening.

### 5.1.3 Snapshots not recalling as expected .....

When a Snapshot is stored, all of the console settings are included but when it is fired only the settings that are included in the Global and individual Recall scopes (ticked in green) will be recalled.

Most channel settings can be made SAFE from all Snapshot recall using the buttons in the channel setup panels that are accessed by touching the top of an on screen channel.

### 5.1.4 Snapshots not inserting as expected .....

When a Snapshot is inserted in the list using the Insert New or Duplicate Selected buttons, the new Snapshot will be placed below the SELECTED Snapshot (the one marked in green) not below the CURRENT Snapshot (the highlighted one in the list)

### 5.1.5 Assigning console controls .....

If you have assigned a bank to the screen and are trying to adjust a specific parameter but something else is being changed it is possible that the worksurface 2nd Function button is active.

If this button is pressed the following alternative controls become available:

- Channel Mute button becomes the Hard Mute button
- Aux ON/OFF switch becomes Aux Pre/Post switch
- Stereo Aux sends become stereo Aux pans
- Output channel coarse delay becomes output channel fine delay

It is also possible that the channel which is being adjusted is not the intended channel - make sure that the correct channels are assigned to the screen by checking the small channel numbers at the top of the on screen channel

### 5.1.6 Channels not appearing on the worksurface .....

If any channels are no longer accessible from the worksurface, it is likely that a bank of channels has been cleared using the **Clear Bank** LCD Function. To get these channels back onto the surface use the **COPY FROM** LCD function in conjunction with the **Layout>Channel List** panel on the Master screen - See the Getting Started Chapter for more details.

### 5.1.7 No signal from the Solo buss .....

If either of the Solo busses don't appear to be passing audio, open the Solos panel on the Master screen and check that the Solo level control at the bottom of the panel is turned up. This is not the same control as the Solo trim on the worksurface and can be set by touching it and using the **Touch Turn** control or, in the case of Solo 2, assigning it to the worksurface **Master Level** control using the button in the on screen Solo panel.

### 5.1.8 Signal from the Solo buss when nothing is soloed .....

When nothing on the console appears to be soloed, it is possible to derive a signal from the Solo buss. This is the result of the **No Solo** function in the Master screen Solos panel being set to monitor either a group or aux buss. By default, the setting allows monitoring of the Master Buss but this can be prevented by touching the No Solo button and removing the Master Buss selection from the Stereo Groups section.

### 5.1.9 External keyboard .....

In order to function correctly the external keyboard must be connected to the console before it is powered on. The console will function without an external keyboard connected but it is very useful for such functions as labelling. Connecting the keyboard after the console has started up will not work - you should **Shut Down**, connect the keyboard and power on again.

### 5.1.10 Resetting the console .....

There are two different types of console reset. There should be no need to use these functions in normal operation but if there is either a computer or audio problem that cannot be resolved in any other way you should be quite clear on the 2 different types of Reset.

**System>Reset Engine** on the Master Screen (F11 is the keyboard equivalent) - this button will reset the audio engine but not the control PC. Be very careful with the use of this function as it will interrupt the audio for a few seconds and can possibly cause unwelcome audio side effects (potential ticks, pops etc)

The **Restart** button on the console rear panel (small square red button next to the MADi connections) - this button will restart the control PC but will not interrupt the audio as the audio engine is not affected. You will have no control of the audio settings until the console has rebooted so it is not advisable to try this in normal circumstances.

### 5.1.11 Talkback .....

The Talkback system in the SD11 requires that a talkback microphone is routed from the console Local I/O or a MADiRack.

Route this socket to the Talkback input in the **Setup>Talkback** panel on the Master screen.

Then route the talkback (TB Outputs) to the required sockets on the Local I/O or a MADiRack. There is a worksurface button that activates the talkback channel and route it to chosen outputs. The talkback level control is on the right hand section of the worksurface.

### 5.1.12 Meters .....

If the console's meters are not working in the required or expected way please check the Options Menu Meter tab on the Master screen - there are several meter configuration to choose from.

### 5.1.13 Console lighting .....

Various elements of the consoles lighting are controlled in 2 different places. On the worksurface in the top right section there are rotary controls for the **touchscreen** brightness and the back panel light socket. On the Master screen Options panel there is a **Brightness** tab where you will find controls for the **Meter LEDS**, the **LCD Displays** and the **Surface LEDS**.

### 5.1.14 Diagnostics .....

If you are experiencing any hardware problems with the SD11 you may be required to check the **System>Diagnostics** panels.

Basic details of these are as follows:

To Open the Diagnostics Panel, touch System>Diagnostics.

The Panel that opens has 4 Tabs; Console, Engine, Audio I/O & Queues

(See Over)

## Chapter 5 - Troubleshooting

### Console

The Console diagnostics provides information about the condition of the console hardware, including power supplies, the worksurfaces and local I/O connection, and other physical interfaces.

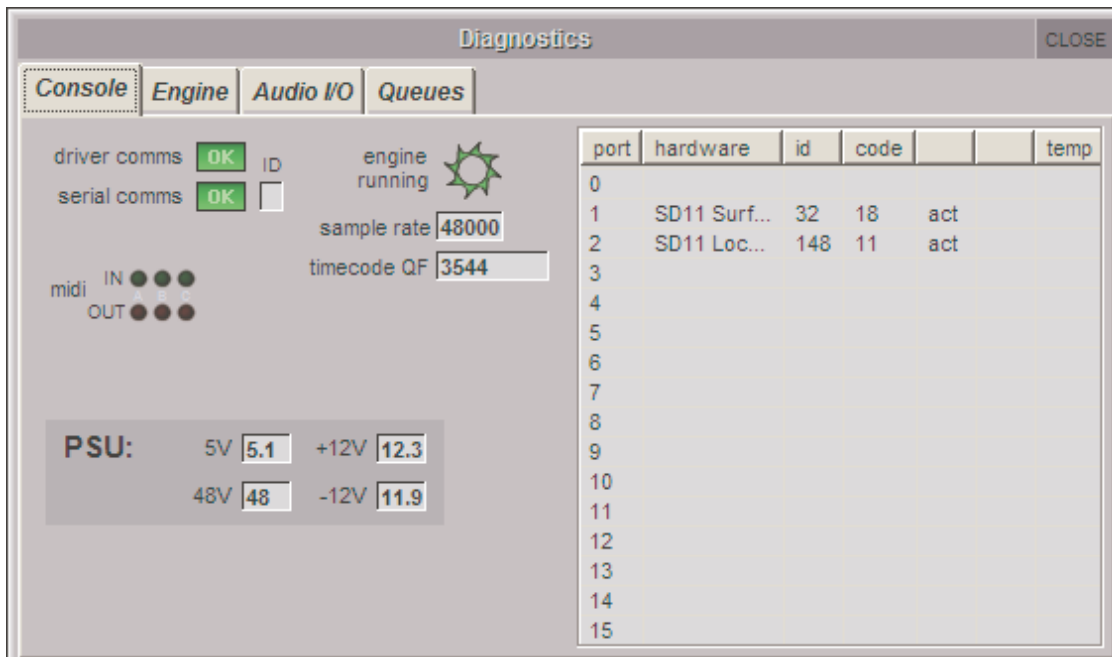

Significant Parameters in the Console Tab are :

**Engine Running Pin Wheel :** When the Engine is running, the Green Pin Wheel will turn continuously. If the Engine stops, the Pin Wheel will turn Red and will stop turning.

**MIDI In / Out :** These activity LEDs show MIDI activity on the physical Ports. If MIDI functions within the Console do not appear to be working correctly, it could be useful to monitor MIDI activity here.

**PSU :** The Power Supply Voltages displayed in the Console Diagnostics are measured on the Local I/O Board, and can help when diagnosing Power Supply problems.

The right hand side of the Console Tab shows the Serial devices of the Console : The worksurface and the Local I/O. For each port or device, the table shows hardware ID, Firmware Code Version and Temperature.

If one of the two serial devices is missing from the list, or not functioning correctly, then a hardware failure has occurred. *Contact your local DiGiCo dealer....*



## Engine

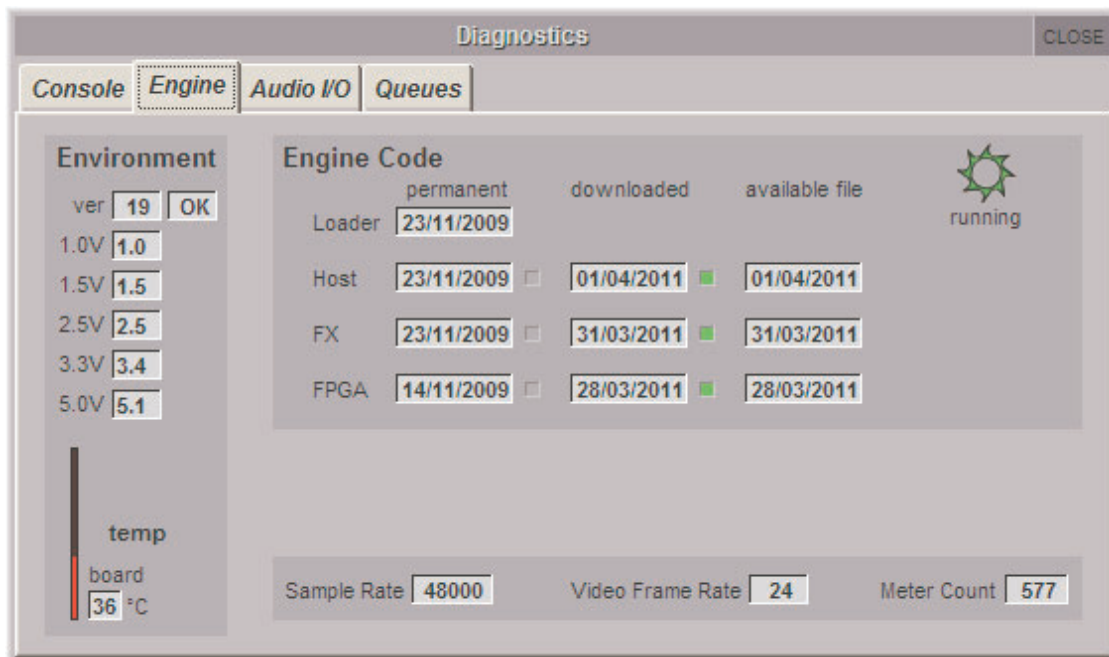

The Engine diagnostics are split into two sections.

The Environment section displays the version of Engine Supervisor Code on the Engine Board. This can only be upgraded with a computer and a Microchip programmer. This is not user-upgradable.

It also shows Power Supply measurements on the Engine Board. These will be displayed as numerical values. If you have a faulty power supply, or a fault on the Engine Board, these values may show as LO. If this is the case, contact your DiGiCo dealer for assistance.

The Engine Code section of the Engine tab displays the release dates of Host Code, FX Code and FPGA Code in the Engine. These codes are written into hardware.

The "downloaded" column will show the dates of the code that the console is actually running. Following a software upgrade, the "available file" dates may be newer than the "downloaded" dates, and if this is the case, you should update your console.

At the bottom of the Engine diagnostics tab, the Sample Rate, Video Frame Rate and Meter Count are displayed. The values here are to assist authorised DiGiCo service partners in locating the cause of specific faults, and have no other practical use.

## Audio I/O

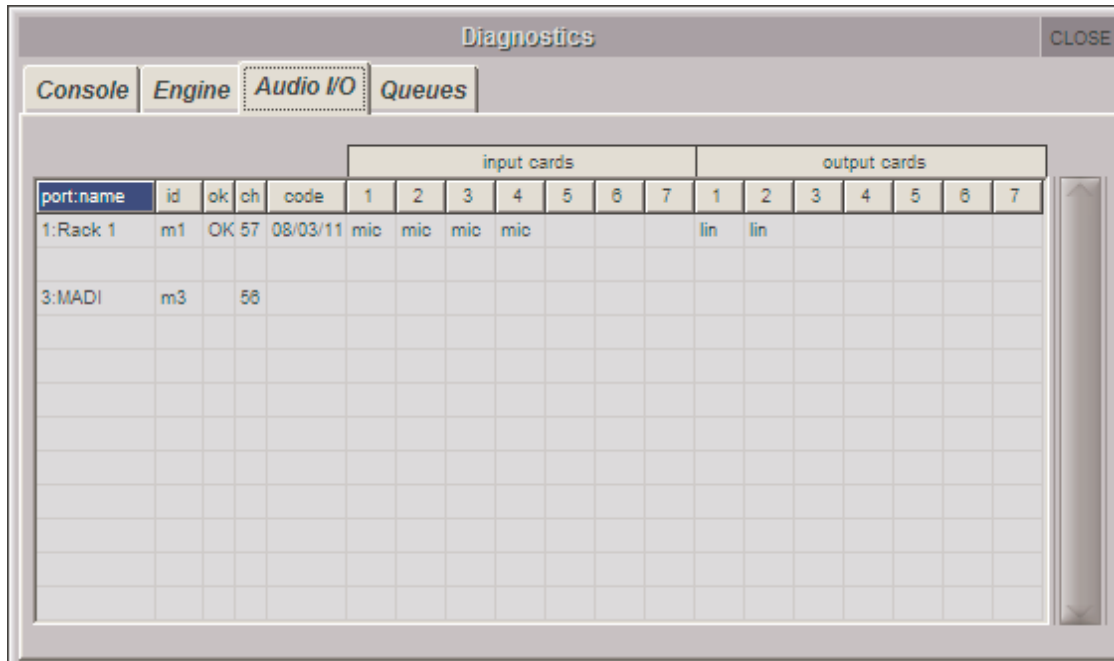

The screenshot shows a software window titled "Diagnostics" with a "CLOSE" button in the top right corner. Below the title bar are four tabs: "Console", "Engine", "Audio I/O" (which is selected and highlighted with a dotted border), and "Queues". The main content area contains a table with the following structure:

port.name	id	ok	ch	code	input cards							output cards						
					1	2	3	4	5	6	7	1	2	3	4	5	6	7
1:Rack 1	m1	OK	57	08/03/11	mic	mic	mic	mic					lin	lin				
3:MADI	m3		58															

The Audio I/O tab provides detailed information about the DiGiCo Racks connected to the console.

The SD11 has one CAT5 D-Rack ports and one MADI Port. For each port, detailed information regarding the configuration of the attached rack is provided. This can be used to track hardware issues, and configuration problems.

In the above example, we can see that Port 1, defined as a Rack, is connected to a rack that is configured with 32 Mic Inputs (4 "cards" of 8 inputs) and two line output cards. It also shows us that the Firmware Code on the rack is dated 8/03/11.

If you are having trouble with specific cards or sockets on the connected rack, or the Audio I/O Panel does not seem to reflect the correct contents of the rack, then the Audio I/O diagnostics can be used to monitor the status of the rack, which cards are installed, and firmware code versions for the connected racks.

Queues

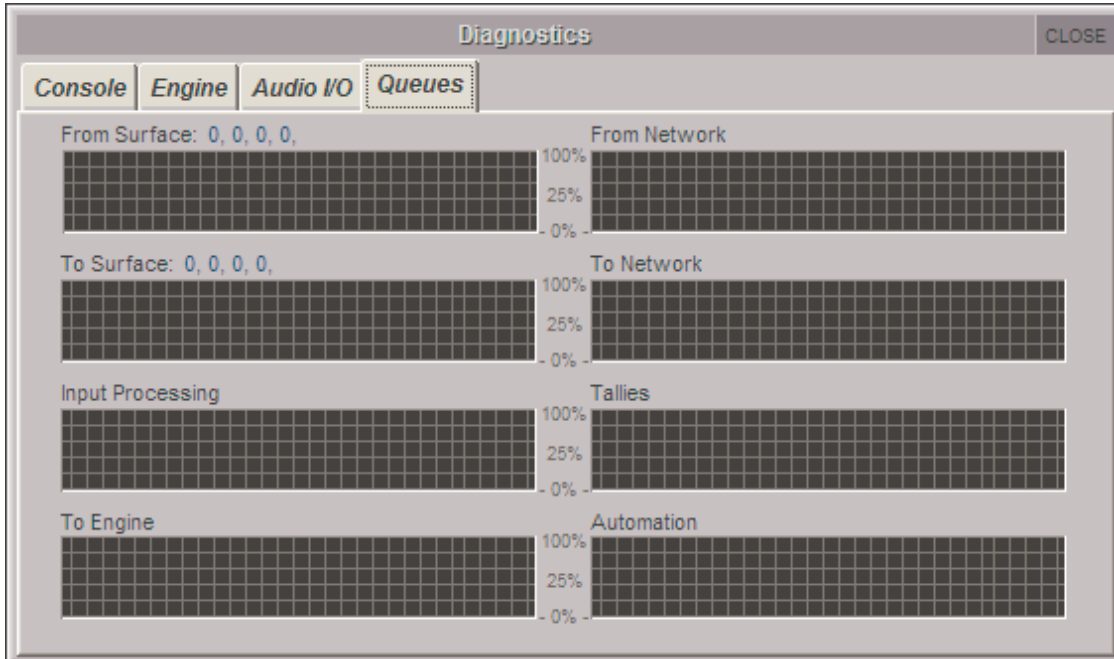

In normal operation the Queues tab will not show any major activity.



# Index

## Symbols

-10 3-35  
 -20 3-34  
 0:Local I/O 1-16  
 2nd function 1-6, 2-2  
 48 3-35

## A

action 3-38  
 Active 3-18  
 add to group 3-14  
 afl 3-30  
 all 1-21, 3-27  
 all mute 2-20  
 all on 1-20, 2-17  
 alt 2-10  
 ALT Input 5-2  
 Assignable Controls 2-11  
 Assigned Channel 1-5  
 assigned to 3-38  
 Assigning Faders 1-12  
 attack 2-17  
 attack rate 3-24  
 Audio I/O 1-8, 3-33  
 Audio Sync 1-14, 3-36  
 Auto Expand Dynamics 3-22  
 Auto Expand EQ 3-22  
 Auto Expand Time 3-22  
 auto gain 2-16  
 auto solo 2-5, 3-30  
 auto-conform all 3-35  
 auto-mute 2-20  
 auto-name 3-35  
 Auto-Route 1-12  
 auto-route 3-5  
 Automatic Conforming 1-9, 3-33  
 Aux Sends 1-12  
 aux to fader 2-13  
 aux to rotary 2-13  
 Auxes 1-15

## B

balance 2-10  
 Bank Switch Assigns Screen 3-22  
 Banks 1-4  
 Brightness 3-24, 5-3  
 build gang 3-28

## C

CANCEL 1-5  
 Caps 1-18  
 Capture 3-20  
 capture 3-38  
 Card/Slot Type 3-35  
 CG MUTE Indicator 2-6  
 Channel Dynamics 2-16

Channel EQ 2-14  
 Channel Faders 1-11  
 Channel Filters 2-14  
 Channel List 3-11  
 Channel Name 1-18  
 Channel Names 2-2  
 Channel Processing 1-19  
 Channel Safes 2-3  
 Channel Select 2-18  
 Channel Solos 2-5  
 Channel Types 1-7, 2-2  
 Channels 1-15  
 CLEAR 1-18  
 clear 3-30  
 clear all 2-13, 3-5  
 Clear All Buttons 1-12  
 Clear Bank 2-22, 5-2  
 clear macros 3-6  
 Clear Over Indicators 3-4  
 Clear PC 3-19  
 clear snapshots 3-6  
 CLOSE 1-5  
 command types 3-38  
 commands 3-38  
 Comp 1-20  
 Configuring a Session 1-11  
 confirm delete 3-7  
 connect all 2-13  
 Connections 1-8  
 Console to Console routing 1-10  
 Control Group Fader Modes 2-20  
 Control Groups 1-22, 2-19  
 Control Surface 1-5  
 Copy 1-18  
 Copy Audio To 1-9, 3-33  
 COPY BANK FROM 3-11  
 Copy Bank From 1-12, 2-22  
 Copy Bank To 2-22  
 Copy Channels 2-3  
 copy from 2-3  
 copy levels from 2-13  
 copy to 2-4, 3-10  
 crossover frequency 1-20  
 Curve 2-14  
 Cut 1-18

## D

Date & Time 3-6  
 Default All 1-11  
 delay 3-31  
 delete files 3-7  
 delete folder 3-7  
 Deleting a Snapshot 3-13  
 Description 3-6  
 Device Type 3-34  
 Direct Sends 1-12

direct sends 3-6  
Display System Alerts 3-26  
Display System Status Indicators 3-26  
duplicate 3-37  
Duplicate Selected 3-12  
Duration Active 3-18  
Dynamics 1-20

## E

edit name 1-17, 2-8  
Editing Multiple Snapshots 3-13  
Effects 1-15  
ENABLE CONSOLE NETWORK 4-2  
Enable Console Network 3-25  
EQ 1-19  
External keyboard 5-3

## F

Fader Banks 3-10  
Filename 3-6  
Files Menu 3-5  
filter frequency 2-17  
fire macro 3-38  
Fire Sends 3-18  
flat 2-14  
FOH and Monitors 4-4  
frequency width 2-17  
full control 3-34  
fx output 2-6  
FX Presets 2-8  
fx Presets 2-8

## G

Gain 1-20  
gain makeup 2-16, 2-17  
GANG 2-6, 2-18, 3-28  
Gate 1-20  
Gate Key 2-16  
Global Recall Scope 3-16  
Global Scope 3-16  
Global Set To Defaults 3-9  
GPI 3-38  
GR 2-16  
Graphic EQ 3-28  
Graphic EQ ALL 3-29  
Graphic EQ Presets 3-29  
Graphic EQs 1-15  
Group & Auto Update Scope 3-15  
Group and Socket Names 3-35  
Group Channels 2-13  
Group Name 3-35  
Groups 1-15  
groups of presets 1-17

## H

HARD 2-6  
headphone 3-32  
hold 2-17

## I

Initial Cap 1-18  
Insert 2-7  
insert 3-37  
insert A 2-6, 2-7  
insert B 2-6, 2-7  
Insert New 3-12  
Insert Routing 2-7  
INTERNAL port 1-15  
IP address 4-2  
isolate 3-34

## J

JOIN CG 1-22, 2-19, 2-21, 2-22  
JOIN/LEAVE 1-22  
join/leave 2-19

## K

key 2-16  
key listen 2-16

## L

L<>R 2-11  
L>L+R 2-11  
Large LCD Names 3-22  
Layers 1-4  
Layout 1-11  
Layout Menu 3-10  
LCD Displays 5-3  
lcd displays 3-24  
LCD Function 1-12  
LCD Functions 2-18  
link 2-16  
link pans 2-13  
Listen To Copied Audio 1-9, 3-33  
Live 3-2  
Load 3-6  
Load Presets 3-8  
Load Session 1-13, 3-6  
Local I/O 3-33  
lock 1-17, 2-8  
LR/LCR Blend 2-11

## M

m-s 2-11  
Macro Editor 3-37  
macro name 3-37  
Macros 3-36  
MADI Recorder Setup 1-9, 3-33  
main 2-10  
Manual Conforming 1-9  
MASTER 3-36  
Master button 3-2  
Master Fader 1-6  
Master FX Display 2-9  
Master Section 3-1  
Matrix 1-21  
Matrix Inputs 3-27  
Meter LEDS 5-3  
meter leds 3-24

**Meters** 3-24  
**MIDI Devices** 3-19  
**MIDI List** 3-20  
**MIDI Program** 3-20  
**MIDI Received Fires Snapshots** 3-18  
**Mirror From Selected** 4-3  
**Mirror To Selected** 4-3  
**Mirroring** 4-2  
**Mirroring Mode** 4-3  
**Misc** 1-15  
**mono** 2-10, 3-31  
**Moving a Snapshot** 3-13  
**moving fader** 2-20  
**MTC** 3-21  
**multi** 1-21, 3-30  
**multi-band** 1-20  
**Multi-console Setups** 4-4  
**MUTE** 2-6  
**mute only** 2-20

## N

**Naming Channels** 1-18  
**Network** 4-2  
**Network Configuration** 4-2  
**new** 3-37  
**new folder** 3-7  
**new group** 1-17  
**Next** 1-18, 2-2, 3-12  
**No Solo** 3-31, 5-3

## O

**on master** 3-10  
**on overview** 3-10  
**Option/All** 1-6  
**Oscillator** 3-2  
**Over Mode** 2-15  
**overs hold** 3-24  
**Overview Clear Screen** 3-4  
**Overview Display** 3-10

## P

**Paste** 1-18  
**peak hold** 3-24  
**pfl** 3-30  
**Port Control** 3-34  
**Port Name** 3-34  
**Port Selection** 3-33  
**ports** 1-15  
**POST** 2-11  
**post fader** 3-24  
**Post-Fader** 3-6  
**post-trim** 3-24  
**PRE** 2-11  
**Pre-Fader** 3-6  
**pre-fader** 3-24  
**Pre-M** 2-11  
**Pre-Mute** 3-6  
**pre-trim** 3-24  
**Presets** 1-17  
**Previous** 3-12

## Q

**Quick Select** 1-5

## R

**R>L+R** 2-11  
**Rack** 3-33  
**Rack Connections** 1-9  
**ratio** 2-17  
**Rebuild Banks** 1-12, 3-6  
**Recall scope** 3-16  
**Recalling a Snapshot** 3-12  
**receive only** 3-34  
**Relative Groups** 3-14  
**release** 2-17  
**release rate** 3-24  
**removable USB** 3-6  
**Rename** 3-13  
**rename file** 3-7  
**rename folder** 3-7  
**Renaming a Snapshot** 3-13  
**ReNUMBER** 3-13  
**Renumbering Snapshots** 3-13  
**Reset Engine** 3-4, 5-3  
**Reset Surfaces** 3-4  
**Restart** 5-3  
**Restructure** 3-5, 3-6  
**REVERT** 3-6  
**Revert To Defaults** 5-2  
**Ripple Channels** 1-16  
**Routing Basics** 1-15

## S

**SAFE** 2-3  
**SAMPLERATE** 3-36  
**Save** 3-7  
**Save As New File** 1-13, 3-7  
**Save Presets** 3-8  
**Save Session** 1-13, 3-7  
**Save Startup Session** 3-25  
**scope** 2-4  
**Screen Assignment** 1-4  
**Screen Scroll** 1-20  
**Security** 3-2  
**select all** 3-7  
**Select Range** 3-13  
**select range** 3-8  
**Selecting Inputs** 1-15  
**Send Session To** 4-2  
**send+return** 2-7, 3-32  
**Session** 3-25  
**Session Report** 3-9  
**Session Structure** 1-11, 3-5, 3-6  
**session title** 3-5  
**set all sends** 2-13  
**Shared** 3-34  
**SHIFT key** 5-2  
**Shutdown** 3-4  
**signal groups** 1-15  
**signals** 1-15



single 1-21, 3-30  
Snapshot Crossfades 3-17  
Snapshot Groups 3-14  
Snapshot Undo 3-14  
Snapshots 3-12  
Snapshots and MIDI 3-18  
Socket Conforming 3-35  
Socket Display 3-34  
Socket Name 3-35  
Socket Options 3-35  
Solo 2-18, 3-23  
Solo 1 3-30  
solo 1 2-5  
Solo 2 3-30  
solo 2 2-5  
Solo Assigns Aux to Faders 3-23  
Solo Assigns Aux to Rotaries 3-23  
Solo Assigns Channel 3-23  
Solo Assigns Channel Also Assigns Screen 3-23  
Solo Choice 2-18  
Solo Reverts to Output 3-23  
Solo Setup 1-23  
Solos Menu 3-30  
Standard MADi Connections 1-10  
Status 3-25  
stereo 2-10, 3-31  
Storing a Snapshot 3-12  
subnet mask 4-2  
Surface 3-22  
Surface LEDs 5-3  
surface leds. 3-24  
swap 3-10  
System Menu 3-2

**T**

talk 3-39  
Talk To Auxes 3-40  
Talkback 3-39, 5-3  
TB Input Route 3-39  
TB Outputs 3-39  
Threshold 1-20  
threshold 2-17  
Timecode & Transport 3-36  
toggle 3-38  
Touch Keyboard 3-22  
touch-turn assignment 3-27  
Track 2-10  
trim 3-30

**U**

Unattended 3-2  
Under Mode 2-15  
update 1-17  
Update Group 3-14

**V**

vca style 2-20

**W**

width 2-10

Word Clock 3-36

